

2023-24

[WWW.DOMOTRAD.LV](http://WWW.DOMOTRAD.LV)

+371 29228597

**Pickleball // Padel Tennis**

Page 3 - 8

Padel-Tennis Systems / Pickle-Ball Systems / Rackets / Balls  
Ball Machines / Net Posts Court Royal / Nets Court Royal / Brooms  
Padel Court complete systems

**Maintenance + Care**

Page 9 - 29

Clay Boxes / Broomsticks / Wheelbarrows / Shovels  
Rakes / Aluminum Plow / Court Brooms / Drag Nets / Combination Leveler  
Line Brushes / Tool Holders / Court Drying / Court Sprinkler / Motor Roller  
Motor Brooms

**Nets + Accessories**

Page 30 - 45

Tennis Nets Court Royal / Tennis Net Posts Court Royal / Center Straps  
Ground Anchors / Net Holdings / Single Net Rods / Mechanic for Tennis Posts  
Spare Parts / Mobile Tournament Net Systems / Court Dimensions

**Court- Accessories**

Page 46 - 71

Marking Lines / Line Covering / Tennisline Speziala + Accessories  
Line Roller + Line Stamper / Sign for Court Rules / Matchpointer  
Umpire Chairs / Advertising Benches / Parasols / Benches  
Shoe Cleaner / Waste Bins / Reservation Plans / Show Cases / Wind Screens  
Dividing Nets / Rubber Granules / Tribune Seats / Tribunes

**Training Walls + Ball Machines**

Page 72 - 78

AIR-Tennis / Smash-Back Training Walls / Tennis Tutor Ball Machines  
Playmate Ball Machines / Training Net Walls

**Training + Equipment**

Page 79 - 86

Multisport-Radar / Ball Collectors / Ball Baskets / Tennisballs / Hurdles  
Marking Markers / Coordination Ladder / Medicine Balls / Foam Balls  
Jump Ropes

**Kid's Tennis + Equipment**

Page 87 - 92

Children's Tennisballs Stage 1-3 / Children's Rackets Stage 1-5  
BIMBI Tennis Systems / Net System Sets / Marking Lines for Kid's Tennis

**Ball Sports + Equipment**

Page 93 -107

Volleyball Posts / Beach Volleyball Posts / Referee Towers / Beach Volleyball  
Marking Lines / Badminton Posts / Volleyball Nets / Badminton Nets  
Football Tennis / Youth Soccer Goals / Handball Goals / Training Goals  
Basketball Systems / Basketball Baskets / Scorli LED-Score Board

**Court Dimensions**

Page 5, 8, 39, 108



# Index

ARTICLE	PAGE	ARTICLE	PAGE	ARTICLE	PAGE
Absorbing Roller Special	23	Information Board	63	Sprinkler	24
Adjustable Nozzle	25	Iso-Line	48	Stabilizing Bracket for Basketball	102
Advertising Bench	56	Jowo Tennis Caddy	82	Stage Balls	88
Advertising Screen	64, 65	Line Brush	20	Stage Rackets	88
Advertising Umpire`s Chair	55	Line Lightning Sweeper	21	Stage Lines	92
Air Tennis	72, 73	Line Master	21	Standard Dividing Net	66, 67
Aluminum Clay Spreader	12	Line Roller	50	Steel Wire Broom	18
Aluminum Multi-Purpose Shovel	11	Line-Stamper	50	Streetball	105
Aluminum Plow	13	Lines	48, 49	Streetball Backboard	104
Aluminum Scraper	13	Line Blitz	21	Support Rod	66
Aluminum Surface Profile Blade	13			Tennis Ball Catcher	80, 81
Badminton	96, 97	Manual Roller	23	Tennis Balls	83, 88
Balls	3, 7, 83, 86, 88	Marking Cone	85	Tennis Benches	56, 57, 58, 59
Ball Back	81, 82	Marking Line	48, 49	Tennis Caddy	82
Ball Basket	81, 82	Marking Lines for Children`s Tennis	92	Tennis Court Drying Set	23
Ball Caddy	81, 82	Marking Strips	48	Tennis Court Reservation Clock	513
Ball Catcher	80, 81	Marking Trolley	50, 90	Tennis Lines	48, 49
Ball Collector	80, 81	Match Liner	21	Tennis Net	32, 33, 34, 53
Ball Machine Padel	8	Match Pointer	53	Tennis Net Post	36, 37, 38
Ball Machine Pickleball	5	Match Timer	51	Tennis Net System	44, 45
Ball Mover	77	Mid Court Tennis Net	89, 90, 91, 92	Tennis Court Broom	18, 19
Ball Pickup Tube	81	Motor Roller	26, 27	Tennis Court Drying Set	23
Ball Throwing Machine	5, 8, 75, 76, 77			Tennis Court Number	51
Basketball	102, 103, 104, 105	Net	32, 33, 34, 35, 66, 67	Tensioning Screw	43
Basketball Backboard	104	Net Post	36, 37, 38, 40	Training Aid	84, 85, 86
Basketball Hoop	103	Net Rod	43, 45	Training Wall	73, 74, 78
Beach Volleyball	95	Numbers	51	Tribune	70, 71
Benches	56, 57, 58, 59	Padel Balls Unlimited	7	Tribune Seats	68, 69
Bimbi Children`s Tennis	89, 90, 91, 92	Padel Court Royal	6	Turbo Broom	29
Broom	7, 18, 19, 20, 67	Paper Basket	61	Turbo Quadrilateral Sprinkler	24
		Part and Full-Circle Sprinkler	24	Tutor Ballmachines	5, 8, 75
Center Strap	4, 42, 45	Pickleball Set	3	Tubular Anchor	49
Children`s Net System	89, 90, 91, 92	Playmate Ballmachine	76, 77	Universal Absorbing Roller Special	23
Children`s Racket	88	Plow	13	Universal Bench Court Royal	71
Circular Sprinkler	24	Practice Wall	73, 74, 78	Universal Sports Post	32, 33, 34, 35
Clax Ball Trolley	81	Professional Broom	18, 19		
Clay Boxes	10	Padel Tennis	6, 7, 8	Volleyball	94, 98
Clay Spreader	12, 13	Pickleball	3, 4, 5		
Coconut Smoothing Mat	15	Rail Aluminum / Wood	17	Waste Bin	61
Collapsible Tennis Post	40	Rake	13	Water Roller	23
Combination Leveler	15	Ranking List	62	Wheelbarrow	11
Combined Hand Leveler	12	Ratchet Tensioner	49	Wind Screen	64, 65
Coordination Ladder	84	Referee Chair	54, 55	Wire Waste Bin	61
Court Dimensions	5, 8, 39, 108	Replacement Marking Strips	48, 49	Wooden Handle	10
Court Royal Tennis Nets	32, 33, 34, 35	Reservation Plan	62		
Court Side Bench	56, 57, 58, 59	Rolldry	23		
Dividing and Stop Net	66, 67	Rubber Rake	12		
Drag Cord	17	Rubber Squeegee	12		
Drag Net	16, 17	Sand Spreader	28		
Drag Net Material	17	School Tennis	88, 89, 90, 91, 92		
Drain Cleaner	12	Scoreboard	52, 53, 106, 107		
Dressing Spreader	13	Seats	55, 68, 69		
Equipment Holder	22	Shoe Cleaner	60		
		Shoe Cleaning Tub	60		
Fitness Dumbell	86	Shovel	11		
Fixing Clamp	49	Showcase	63		
Folding tripod	24	Sign for Court Rules	51		
Frankfurt Shovel	11	Single Net Rods	43, 45		
		Small Court Tennis Net	89, 90, 91, 92		
Geka Adapters	25	Smash Back	74		
Granulate	67	Smoothing Mat	16, 17		
Granulate Broom	18, 67	Smoothing Mat, hard PVC	16		
Granu-Top	18, 67	Soccer	100, 101		
Ground Sleeves	36, 37, 41	Softball, yellow	83		
		Spare Parts for Tennis Net Posts	41		
Hand Brush	20	Special Rake	13		
Hand Brush Holder	22	Special Adapters	40		
Hand Leveler	12	Special Smoothing Mat for Silica	159		
Handball Goal	101	Speed Trac Sports Radar	80		
Handle Holders	22	Speziala Lines	49		
Handle Holders	22	Spray Nozzle	25		
Handles	10				
Hose	25				

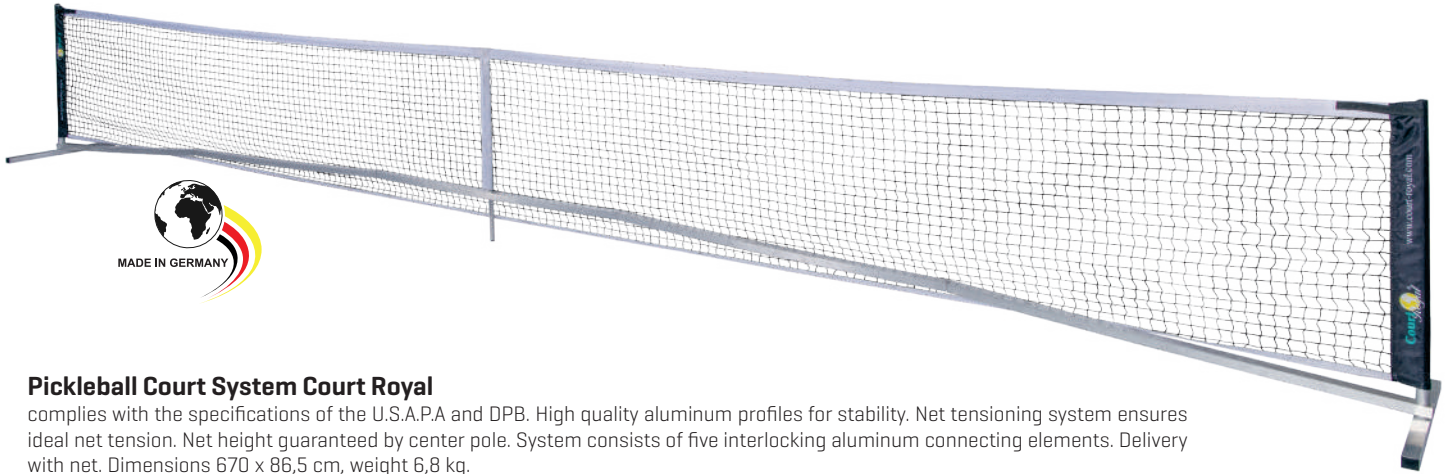

## Pickleball Court System Court Royal

complies with the specifications of the U.S.A.P.A and DPB. High quality aluminum profiles for stability. Net tensioning system ensures ideal net tension. Net height guaranteed by center pole. System consists of five interlocking aluminum connecting elements. Delivery with net. Dimensions 670 x 86,5 cm, weight 6,8 kg.

No. 404231

## Pickleball Replacement Net

With side pockets, 670 x 80 cm

No. 404238



## Portable Pickleball System Alu Court Royal Professional

Heavy transportable tournament equipment from our own production. The aluminum frame has a profile of 80x80 mm and is completely black powder coated. Equipped with a tensioning mechanism [internal], the professional net can be adjusted to the desired height. Two diagnostic supports ensure optimal stability of the system. With standard dimensions of 670 x 68,5 cm, the system is suitable for tournaments. Black powder-coated, complete dimension: approx. 681x93 cm. Without net.

Ohne Netz.  
No. 404233



## Yoorna Tinia 2.0

Tinia 2.0 is the perfect model for beginners and hobby players. This paddle has a rounded shape and is made of wood with a weight of appr. 300 grams. The qualitative handle with a circumference of 10 cm and a length of 13 cm, fits perfectly in the hand. An attached edge protector defends the paddle from damage. More power with less force due to higher weight. Tinia 2.0 complies with the specifications of the USAPA and DPB.

No. 404240



## Center Strap II T

Made of nylon with adjustment loops, without snap hooks.

No. 407101



## Pickleball ball set of 3 outdoor

Outdoor ball with 40 holes for a safe and precise flight. The two-piece construction ensures a continuous bounce. Approved tournament ball according to the official list of USA Pickleball and IFP Pickleball. Weight: approx. 20 g Color: neon yellow

No. 404252



## Pickleball ball set of 3 indoor

Indoor ball with 26 holes for a safe and precise flight. The two-piece construction ensures a continuous bounce. Approved tournament ball according to the official list of USA Pickleball and IFP Pickleball. Weight: approx. 20 g Color: neon green

No. 404250

# Pickleball + Equipment



## Pickleball - Net PN 5

Made of approx. 3 mm polyethylene braided rope, hand-knotted, black, knotted inside, very sturdy plastic double net border, complete with plastic-coated steel rope. Side and bottom edges with heavy, black plastic edging, as well as two 10 mm thick glass fiber rods for lateral fixation. Long life and best durability. 3 years factory warranty on the net.

Dimensions: 660 x 80 cm

Mesh size: 4,5 cm

No. 404230

## Pickleball - Post Alu PP 73

Round post  $\varnothing$  73 mm made of green plastic-coated aluminum. Special profile with three compartments, very sturdy with screw-on gear wheel mechanism of aluminum. Net holding rod and all screws and hooks are made of VA steel. Delivery without ground sleeves. Total length: 125 cm, above ground: 90 cm

No. 404222 green

No. 404223 black

## Ground Sleeves 73

Ground sleeves for 73  $\varnothing$  mm post

No. 404281



## Center Strap III

With plastic snap lock, spring hook and Velcro strip.

No. 40720

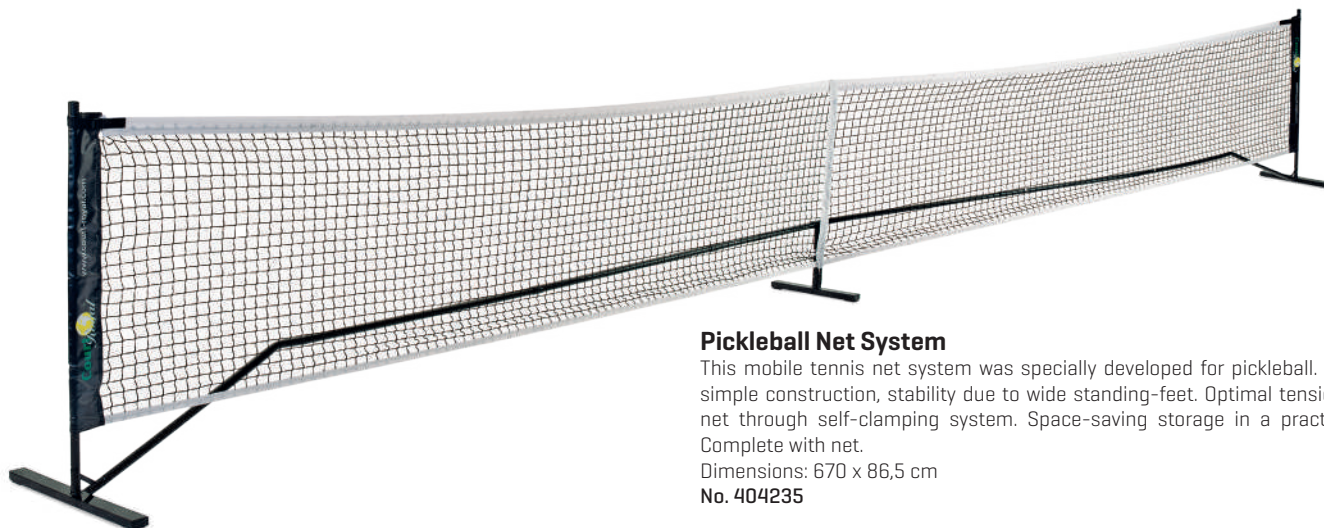

## Pickleball Net System

This mobile tennis net system was specially developed for pickleball. Fast and simple construction, stability due to wide standing-feet. Optimal tension of the net through self-clamping system. Space-saving storage in a practical bag. Complete with net.

Dimensions: 670 x 86,5 cm

No. 404235

## Pickleball Net System Replacement Net

With side pockets 670 x 80 cm

No. 404238

# Pickleball + Equipment

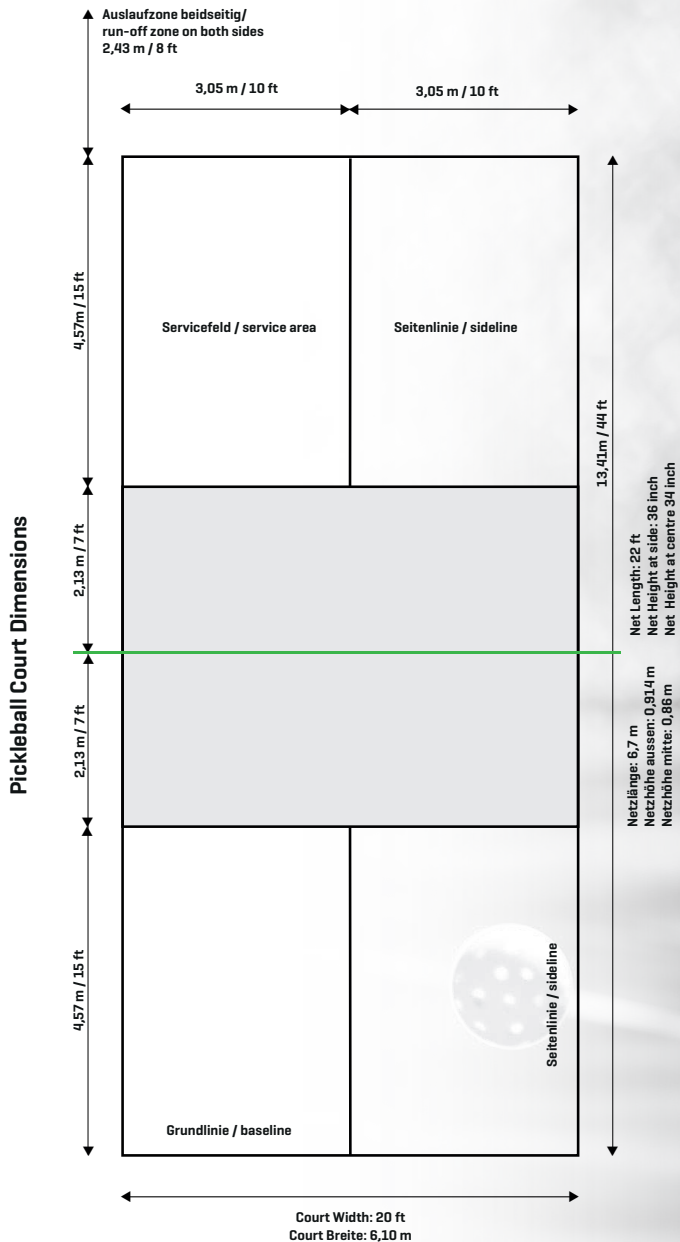

## Ball Machine Pickleball Tutor Mini

The new ball thrower is a novelty and was designed specifically for pickleball. Fully equipped and incredibly user friendly. The compact design with 38 x 33 x 30 cm paired with a low weight of around 11 kg allows optimal transport. With the manual height control, a feed from groundstroke to lob is easily possible. Imposing ball speeds of up to approx. 80 Km/h cover every need. A regular ball sequence can be set individually between 2 and 10 seconds. Dynamic training is provided by an oscillator, which distributes the balls variably over the playing field. Great capacity of up to approx. 60 outdoor or indoor balls. Built-in rechargeable battery allows up to approximately three hours of play time per charge.

### Technical details:

Ball capacity:	appr. 60 Balls
Dimensions (HxWxD):	38 x 33 x 30 cm
Weight (with battery):	ca. 11 kg
Power:	battery
Playing time:	2 - 3 hours
Recharging time:	12 Std.
Feeding interval:	2-10 sec.
Top speed:	appr. 80 km/h
Ball flight:	manually adjustable (lob/round shot)
Line-directions:	one direction and randomly
Ball type:	indoor and outdoor
Housing:	plastic
Remote control:	none, on-off switch

No. 404270



## PADEL COURT ROYAL Complete system ready to play

Complete system 10x20m for indoor and outdoor. Complies with the regulations of the German Padel Federation (DPB) and the International Padel Federation (FIP). Construction according to EN 10219 with hot-dip galvanized steel and thermosetting polyester paint. All screws made of stainless steel. Tempered safety glass according to EU standard with 10 mm and quality rubber seals. Advance artificial grass with quartz sand filling and lining available in various colors. Adjustable paddle net with posts. Two entrances in WPT design with a width of 100 cm. In addition, the Court can be equipped with four floodlight poles with LED spotlights (not included in delivery). A solid ground is required for the construction of a foundation. For outdoor a strip foundation with permeable asphalt is recommended. Price: on request

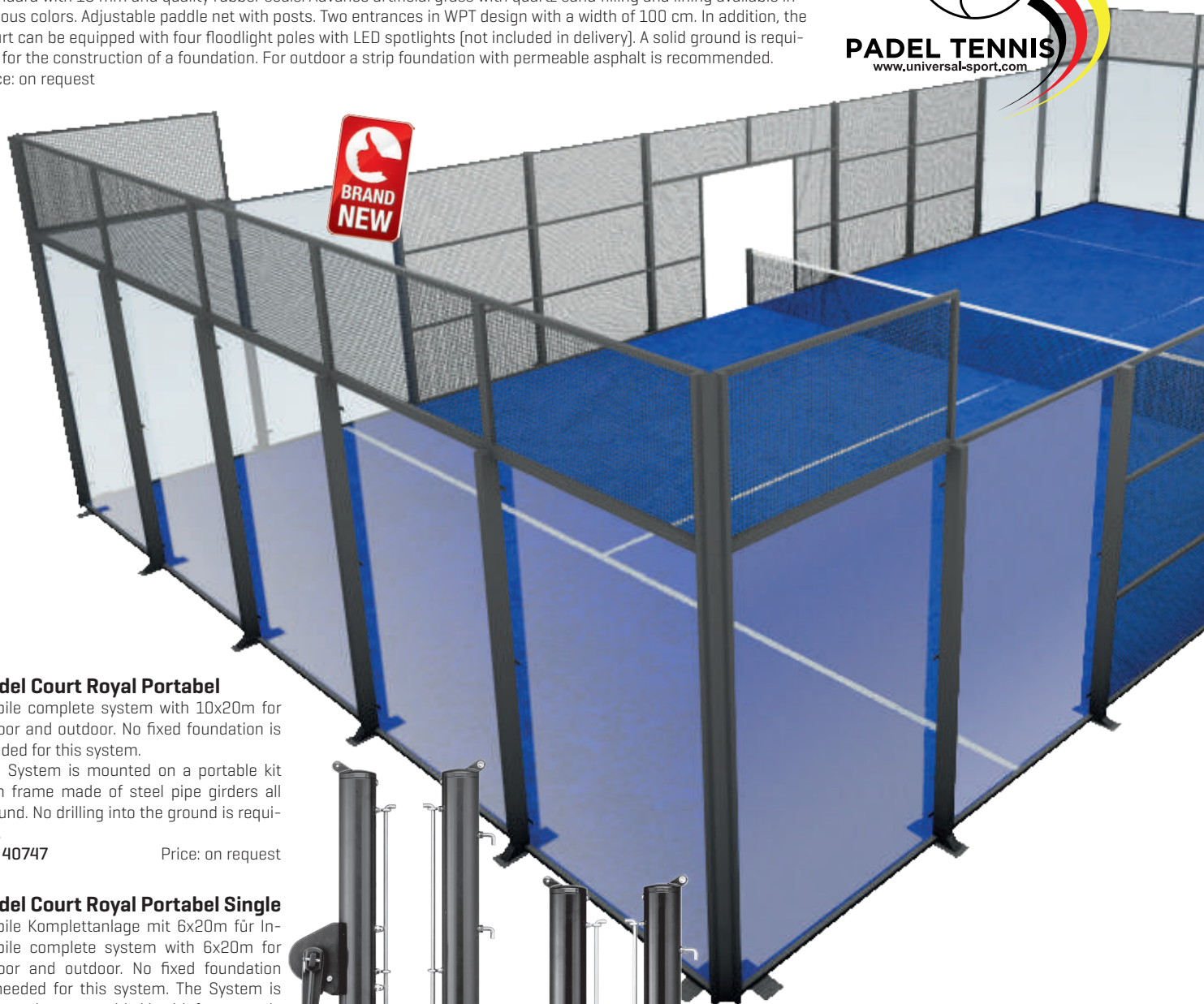
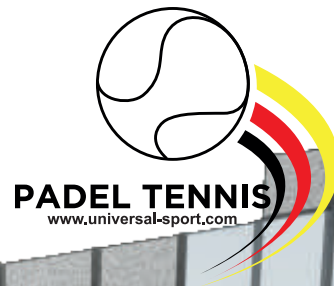

## Padel Court Royal Portabel

Mobile complete system with 10x20m for indoor and outdoor. No fixed foundation is needed for this system.

The System is mounted on a portable kit with frame made of steel pipe girders all around. No drilling into the ground is required.

No. 40747

Price: on request

## Padel Court Royal Portabel Single

Mobile Kompletanlage mit 6x20m für In-Mobile complete system with 6x20m for indoor and outdoor. No fixed foundation is needed for this system. The System is mounted on a portable kit with frame made of steel pipe girders all around.

No drilling into the ground is required.

No. 407471

Price: on request



## Padel Tennis Netpost

### PP 73 BH

Round post  $\varnothing$  73 mm made of green plastic-coated aluminum. Special profile with three compartments, very sturdy with screw-on gear wheel mechanism of aluminum. Net holding rod and all screws and hooks are made of VA steel. Delivery without ground sleeves.

Total length: 125 cm, above ground: 92 cm

No. 40635

### Padel Tennis Netpost PP 73 with plate

Round post  $\varnothing$  73 mm made of green plastic-coated aluminum. Special profile with three compartments, very sturdy with screw-on gear wheel mechanism of aluminum. Net holding rod and all screws and hooks are made of VA steel. With base plate for attachment to the concrete slab with dowels.

Length above ground: 92 cm

No. 40636

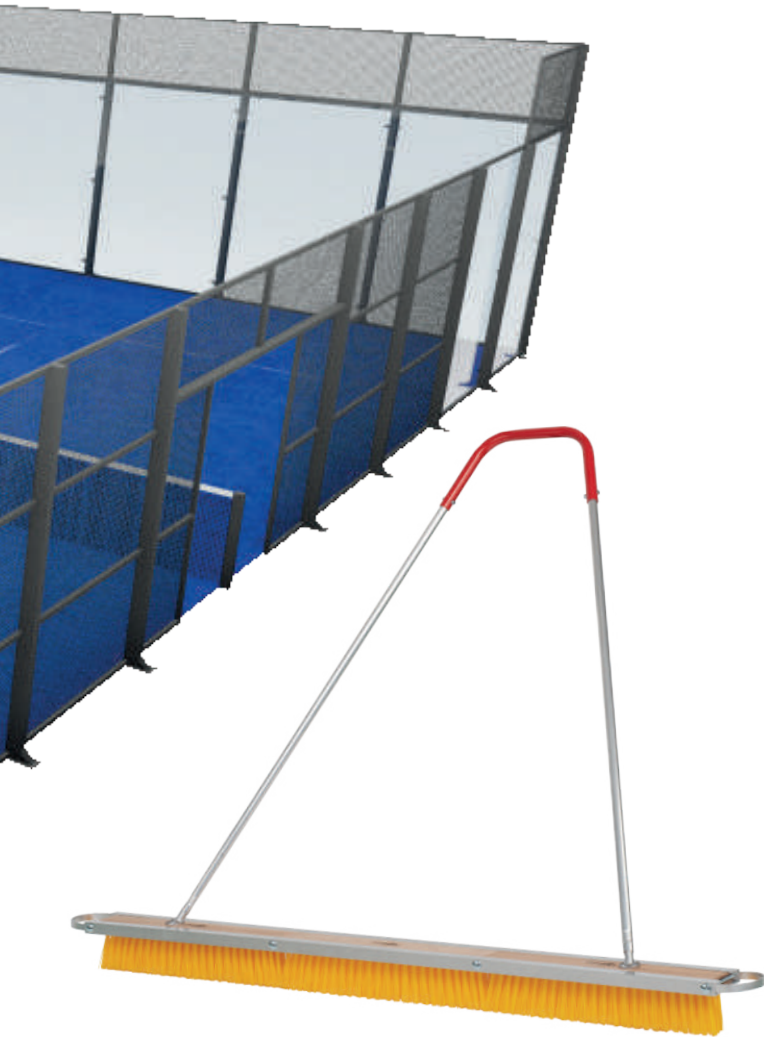

### Padel Court Broom Plastic yellow

150 cm wide, with 3 interchangeable broom parts on an aluminum base rod. Complete with a three-part, very stable aluminum pull bar and mountable net deflectors. The optimal care broom for synthetic turf surfaces filled with quartz sand. Bristles plastic yellow, slanting.

No. 408811

### Replacement Brush Plastic yellow

No. 40883 50 cm



### Padel Balls unlimited

A combination of a robust rubber core and a high-quality felt layer meet the special requirements of padel play. Good ball control and a solid hitting point are guaranteed. Compared to the tennis ball, the internal pressure is reduced. This slows down the game and changes the bounce height. Weight: approx. 56 g.

No. 40638 3-pack can

No. 40637 4-pack can

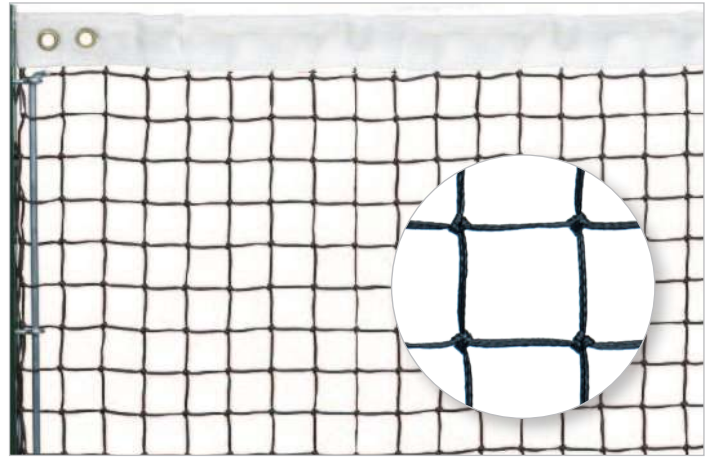

### Padel Tennis Net PN 8

Made of about 3 mm polypropylene, high-strength, black, PES mesh tape. Complete with plastic-coated steel cable. Dimensions: 1000 x 92 cm.

Mesh size: 4,5 cm

No. 40630



### Padel Tennis Netz PN 9

Very sturdy plastic double netting, complete with plastic-coated steel cable. Side and bottom edges with heavy, black plastic edging, as well as two 10 mm thick glass fiber rods for lateral fixation. Long life and best durability. 3 years factory warranty on the net. Dimensions: 1000 x 92 cm

Mesh size: 4,5 cm

No. 40631



### Center Strap III

With plastic snap lock, spring hook and Velcro strip.

No. 40720



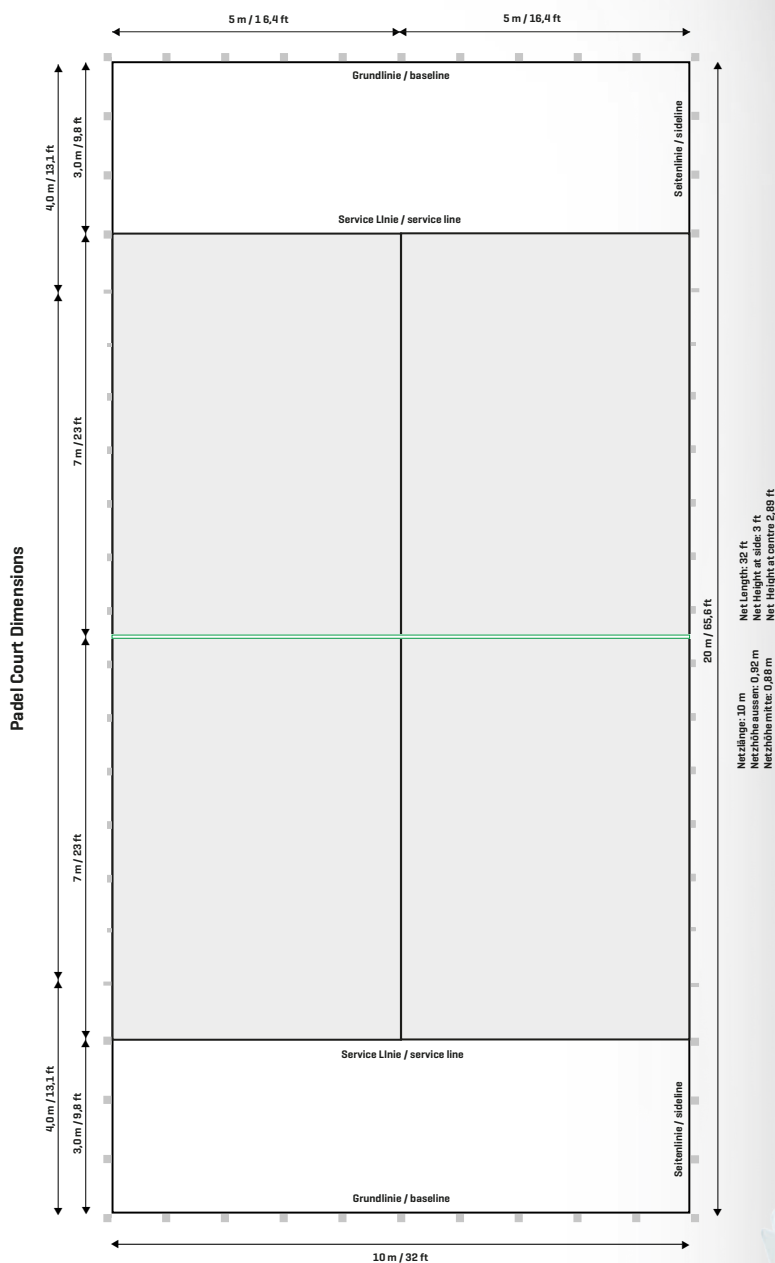

## Ball Machine Padel Tutor Plus

The Tennis Tutor Padel is a battery-powered ball thrower and specially designed for padel balls. With compact dimensions of 51x50x51 cm and a weight of only 21.6 kg, this machine is ideal to transport. Thanks to the extendable handle and wheels, the machine can be pulled as a trolley. An individual adjustment of the ball speed is possible from a slow ball to a high-speed ball with fulminant 136 km/h. The trajectory can be varied between net roll and lob, a regular ball sequence or random scatter angle in 1.5-10 seconds. The practical, fold-out ball container holds approx. 150 balls. With 4-6 hours of battery life, extensive training is easily possible without interruptions to recharge the ball thrower.

### Technical details:

Ball capacity:	ca. 150 balls
Dimensions (HxWxD):	51 x 50 x 51 cm
Weight (with battery):	21,6 kg
Power:	battery
Playing time:	4 - 6 hours
Recharging time:	12 Std.
Feeding interval:	1,5-10 sec.
Top speed:	136 km/h
Ball flight:	short to long
Line-directions:	topspin, spin, flat, slice
Housing:	plastic
Remote control:	yes on/off
<b>No. 40640</b>	





Maintenance + Care



## Clay Box

A combination of fiberglass-reinforced plastic and resin make this clay box very stable. The material is UV and weather resistant. Metal parts are stainless steel. Every clay box has a hinged lid.  
Color: grey, orange.

No. 41290	700 kg	550 Ltr.	134 x 99 x 78 cm	
No. 41300	1100 kg	700 Ltr.	134 x 99 x 96 cm	
No. 41301	1100 kg	700 Ltr.	134 x 99 x 96 cm	Material removal below
No. 41310	1500 kg	1100 Ltr.	163 x 121 x 101 cm	
No. 41312	2200 kg	1500 Ltr.	163 x 121 x 101 cm	Material removal below



### Handle for ROYAL ①

Made of aluminum, Ø 23 mm, length 1,48 m [see page 14]\*  
No. 411131

### Handle for NUOVO ②

Made of aluminum, Ø 22 mm, length 1,31 m [see page 14]\*  
No. 411261

### Handle for NUOVO ③

Made of wood, Ø 25 mm, length 1,57 m [see page 14]\*  
No. 41127

### Handle for ROYAL ④

Made of wood, Ø 23 mm, length 1,46 m [see page 14]\*  
No. 411132

### Wooden handle 28 mm ⑤

28 mm Ø, slightly tapered, 1,5 m long. For aluminum scraper, wooden rakes, aluminum rakes, plows.  
No. 40094

### Wooden handle 24 mm ⑥

24 mm Ø, 1,5 m long. For rakes, rubber rakes, line sweepers, line guider, match liners, line brooms.  
No. 40091

\*) Dimensions not binding



# Maintenance + Care



### Wheelbarrow Standard

Capacity: 85 l, 240 kg. Galvanized barrow with beaded rim, 1 pneumatic tire 400 x 100 mm with nylon sleeve bearing.  
No. 40103

### Wheelbarrow Universal 100 l

Capacity: 100 l. Seamless pressed, galvanized barrow with sturdy rounded rim, 2 pneumatic tires, load 300 kg.  
No. 401021



### Wheelbarrow Court Royal

This newly developed wheelbarrow for tennis sand should not be missed on any tennis court. Capacity 250 l, polyethylene synthetic bottom, 6 mm wall thickness, allround stable rim, break proof, high abrasion resistance and complete UV-stability, stable 1" tubular steel frame, phosphated and plastic-coated, reinforcing cross-bars for stable bottom, simple emptying via tube runners, ball bearings air tyres with pneumatic wheels, size 400 x 80 mm, load-carrying capacity 350 kg.  
No. 401025



### Aluminum Multi-Purpose Shovel

To spread clay or to remove old material and leaves, complete with handle.  
No. 40101                      Size: 380 x 380 mm  
No. 40100                      Size: 370 x 270 mm



### Frankfurt Shovel 1]

Round shovel made of steel, painted red, oil-hardened with ashwood handle.  
No. 40099

### Holstein Shovel 2]

Square shovel made of steel, painted red, oil-hardened with ashwood handle.  
No. 40098

# Maintenance + Care



## Drain Cleaner A

To clean drain gutters. 5 cm wide, complete with wooden handle.  
No. 40030



## Guide Bar

Made of aluminum, collapsible, light construction, simple to handle. An essential tool for the groundkeeper for checking levels and finding hollows. Length 10 cm.  
No. 40033



## Hand Leveler

Made of aluminum, with rubber blade. To wash in the top covering and clear puddles, 200 cm wide.

No. 40020

Spare rubber blade for hand leveler

No. 40021



## Rubber Squeegee

Steel bar with rubber blade. Specially intended for stone removal. Light leveling of loose courts and water removal on hard surfaces, 100 cm wide, handle included.  
No. 40022



## Rubber Rakes

For fast removal of leaves and rubbish, without handle.

No. 40090 50 cm wide

No. 40089 70 cm wide

**Wooden Handle Ø 28 mm** for Rubber Rakes.

No. 40094



## Aluminium Clay Spreader

To fill in holes and level irregularities, 100 cm wide, without handle.

No. 40060

**Wooden Handle Ø 28 mm**

for Rubber Rakes.

No. 40094

# Maintenance + Care

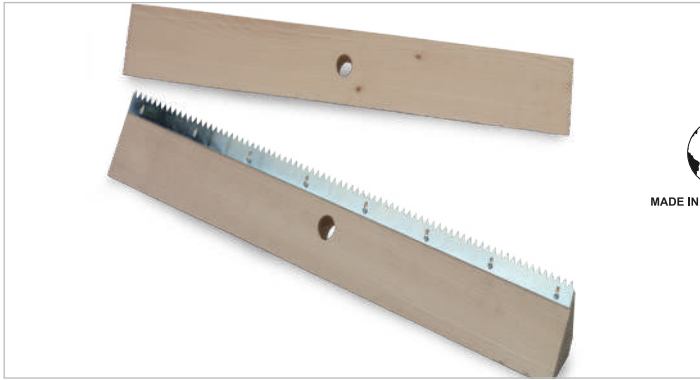

## Wooden Rake

Triangular beech wood, 70 cm wide with saw blade, without handle.

No. 40040

**Wooden Rake** as above, though without saw blade.

No. 40042

**Saw Blade** for wooden rake.

No. 40051

## Wooden Handle Ø 28 mm

No. 40094

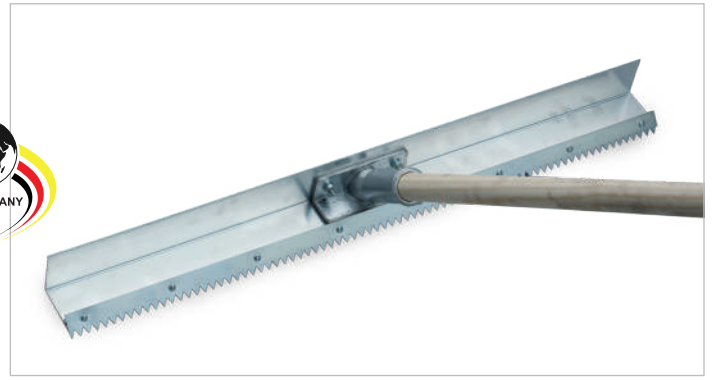

## Aluminum Plow

One side with steel band saw blade, the other side with solid profile, 70 cm wide.

No. 40050

**Saw Blade** for plow

No. 40051

## Wooden Handle Ø 28 mm

No. 40094

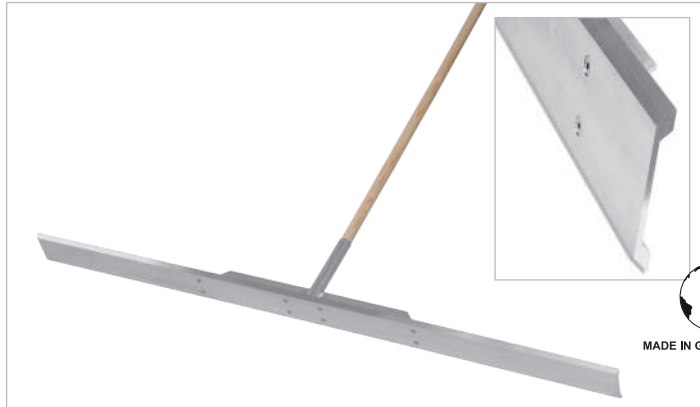

## Aluminum Surface Profile Blade

To smooth out irregularities, without handle.

No. 40080 80 cm wide

No. 40081 150 cm wide

## Wooden Handle Ø 28 mm

No. 40094



## Aluminum Scraper

Double-sided tool, one side toothed to roughen surface, other side flat for spreading. 80 cm wide, without handle.

No. 40070

## Wooden Handle Ø 28 mm

No. 40094

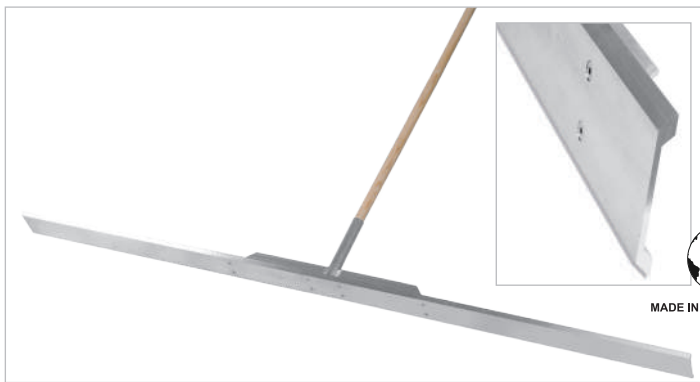

## Dressing Spreader

Trapezoidal shaped aluminum section dressing spreader. Light and easy to handle yet robust for precise distribution of material over large areas, 200 cm wide, without handle.

No. 40084

## Wooden Handle Ø 28 mm

No. 40094



## Special Rake

Made of stainless steel, corrosion-resistant, for professional smoothing of clay courts, 66 cm wide, without handle.

No. 40083

## Wooden Handle Ø 28 mm

No. 40094

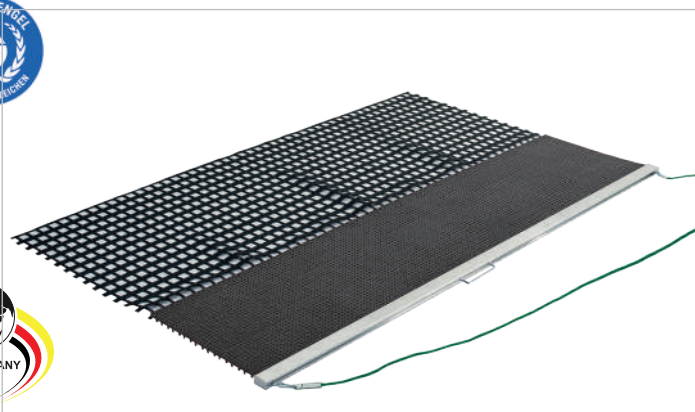
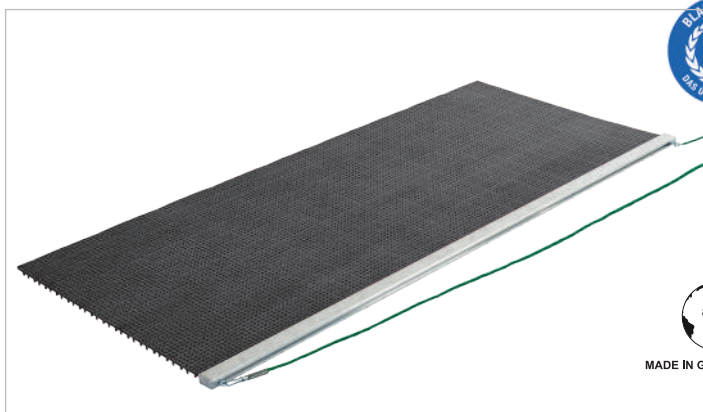

## Hard PE Smoothing Mat

The newly developed aluminum profile perfects the long-standing concept of the drag mat hard PE and combiplaner. Due to the 15 x 20 cm individual segments a maximum flexibility of the whole application is given. The manifold scratch elements at the bottom side are ideal for roughening the place and at the same time for smoothing the unevenness and cleaning from leaves without damaging the surface. Especially suited for Cannada -Tennis, artificial grass courts and clay courts. All used material is extremely weather resistant and low wear. Dimensions: 185 x 75 cm

No. 41070

## Combination Leveler

The newly developed aluminum profile perfects the long-standing concept of the drag mat hard PVC and combiplaner. This special tool combines the advantages of the drag mat Hard PVC and that of a drag net. The PVC front part opens and clears unevennesses and with the rear part of the heavy drag net the open places are smoothed again and scratched filth gets dragged along. All used material is extremely weather-resistant and low-wear.

Working width: 185 cm

No. 41079

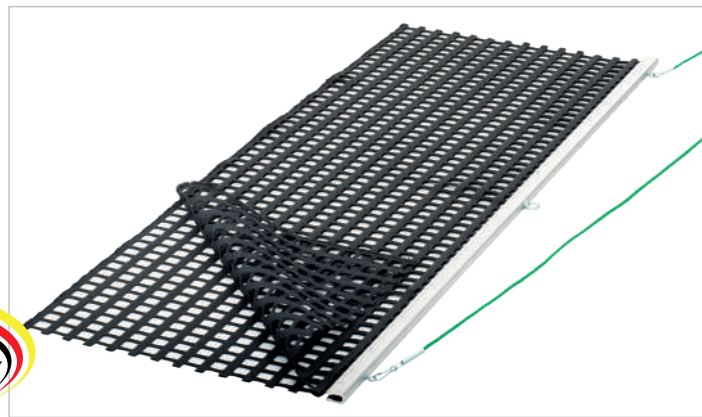
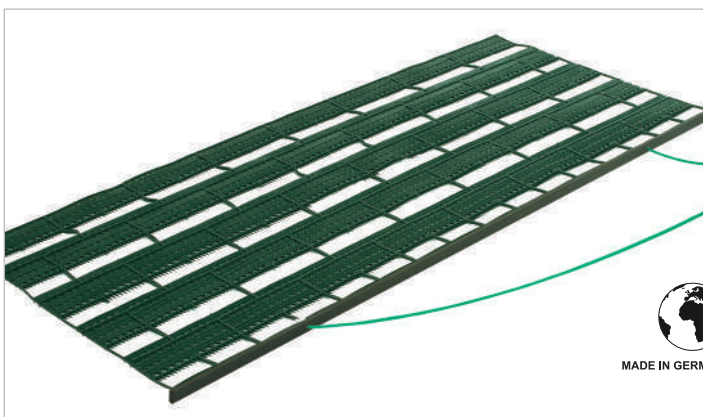
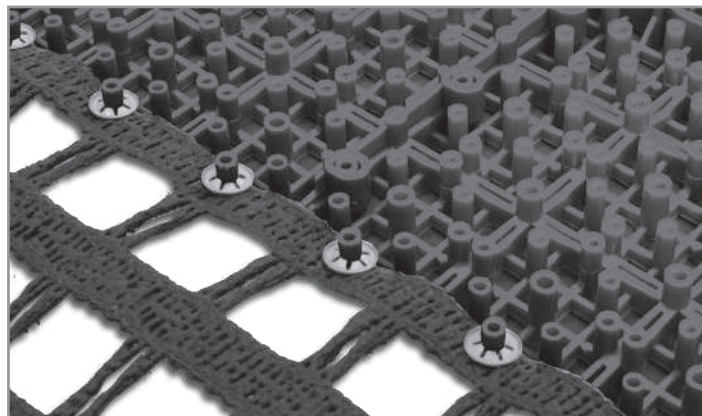

## Smoothing Mat Super Clean

This mat was developed to remove foliage, leaves, pine needles, etc. in an effective and quick way. This is possible through the smoothing with the Super Clean drag net which leads to excellent court leveling. After the smoothing a shaking out of the net outside the court is sufficient. The net should be kept flat on the ground while using. Dimensions: 230 x 66 cm.

Includes aluminum rail with drag cord.

No. 41077

## Uniplan 75

Heavy aluminum pull rod to level the tennis court surface, special PVC fabric extra, double.

Working width 190 cm. Net depth 75 cm with pull rope.

No. 410309

# Maintenance + Care



## Broom-Mat Platzfit 150

Combination broom and mat. Consists of a broom with plastic bristles and PVC drag net. Aluminum rail and handle.

No. 41071 working width 150 cm

### Replacement Brushes 150 cm

No. 410712

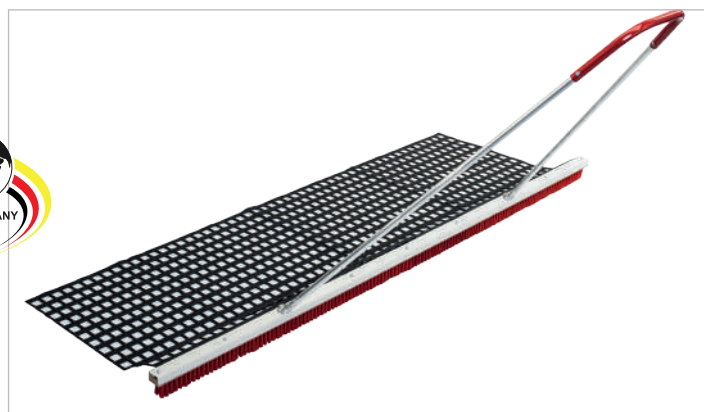

## Broom-Mat Platzfit 200

Combination broom and mat. Consists of a broom with plastic bristles and PVC drag net. Aluminum rail and handle.

No. 41072 working width 200 cm

### Replacement Brushes 200 cm

No. 410710



## Combined Broom

The new Combination broom and net. The top court equipment for clay and granular courts. Consists of a plastic/Arenga broom and PVC special net. Aluminum rail and handle.

No. 41073 working width 200 cm

### Replacement Brushes 50 cm

No. 40936

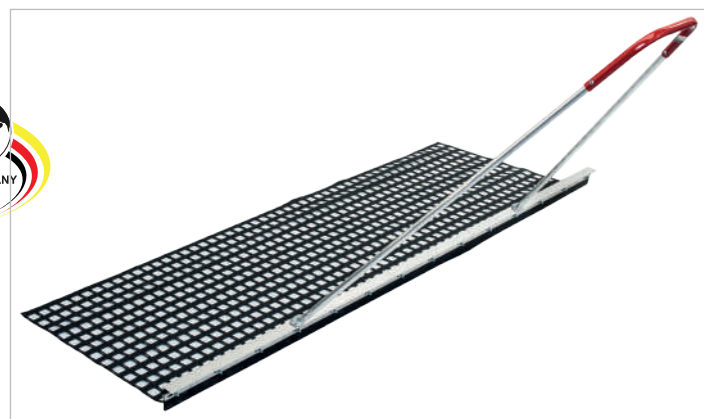

## Combined Hand Leveler

Combination hand leveler and drag net. The ideal tool for smoothing courts after sprinkling or rainfall. Due to the rubber blade and the drag net two operations are done in half the time. Fills unevenness and smoothes the court surface.

No. 41078 working width 200 cm



## Coconut Smoothing Mat

Heavy-duty coconut mat with PVC edges 200 x 100 cm. Wooden rail with drag cord.

No. 41060

### Replacement Smoothing Mat

Size 200 x 100 cm

No. 41050

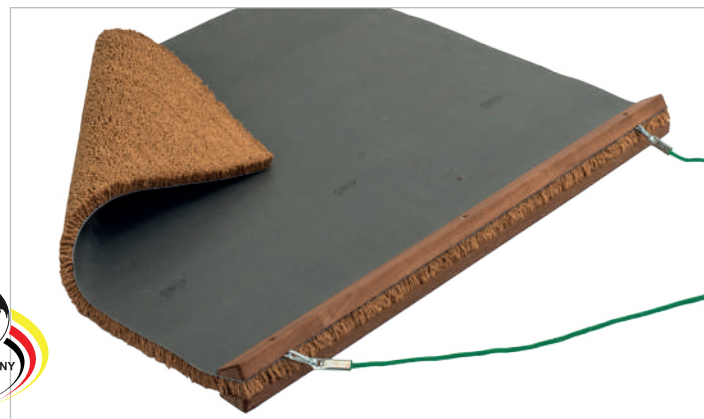

## Special Smoothing Mat for Silica Sand

3 cm long coconut fibers, cast in PVC material. Complete with drag cord.

Size 120 x 90 cm

No. 40885

### Replacement Special Smoothing Mat

Size 120 x 90 cm

No. 40886



# Maintenance + Care

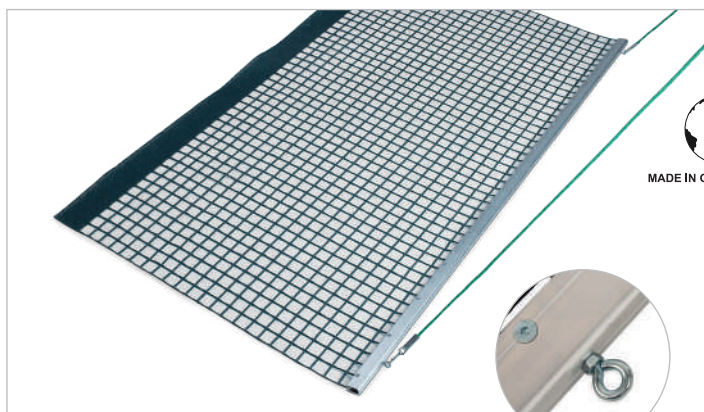

## Aluminum Drag Net, Single PVC

One PVC-coated net 200 x 115 cm, with aluminum rail. Suitable for clay and shale courts.

No. 40980

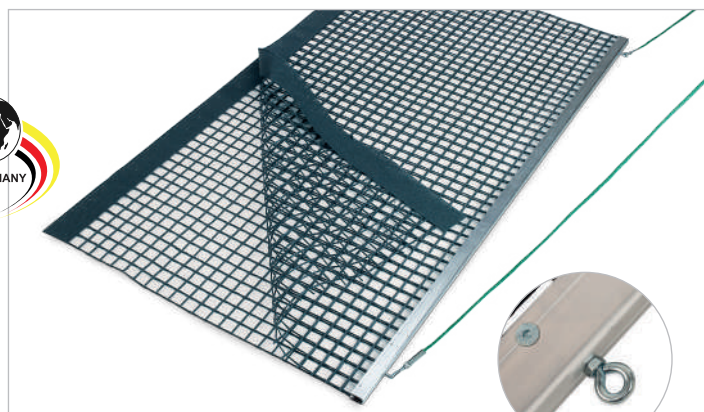

## Aluminum Drag Net, Double PVC

Two PVC-coated nets 200 x 115 cm, with aluminum rail. Suitable for clay and shale courts.

No. 41010

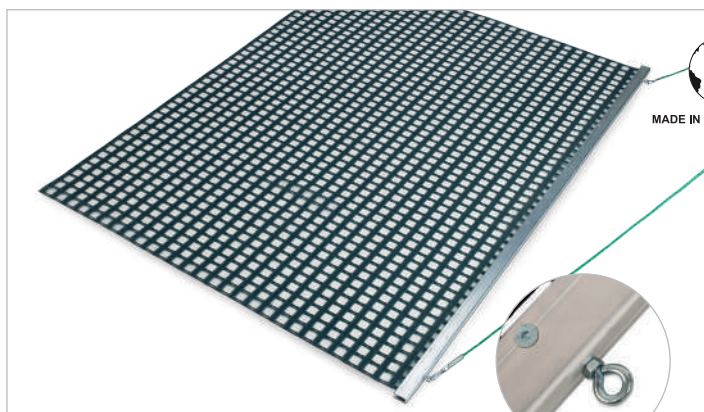

## Aluminum Drag Net, Special Single

One Extra-PVC fabric net with aluminum rail and drag cord. Working width 200 cm, depth 150 cm.

No. 410301

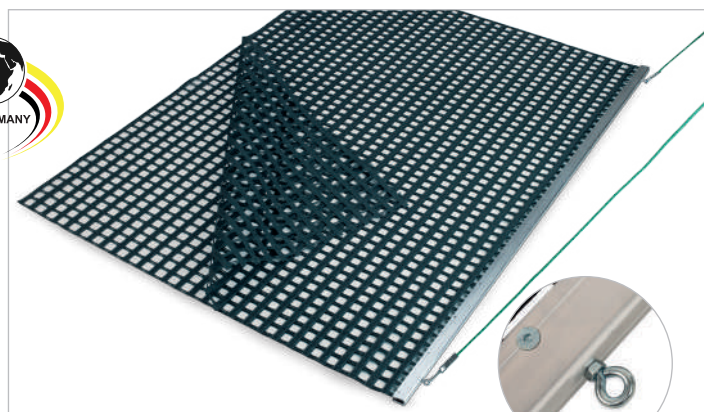

## Aluminum Drag Net, Special Double

Two special-PVC fabric nets with aluminum rail and pull-handle. Working width 200 cm, depth 150 cm.

No. 410302



## Uniplan Exclusiv Court Royal

The new drag net of a special kind. Special PVC fabric extra, double with working width of 75 cm. Made for all kinds of sand courts. Developed with the expertise of customers for customers. Working width 190 cm, depth 75 cm.

No. 41024

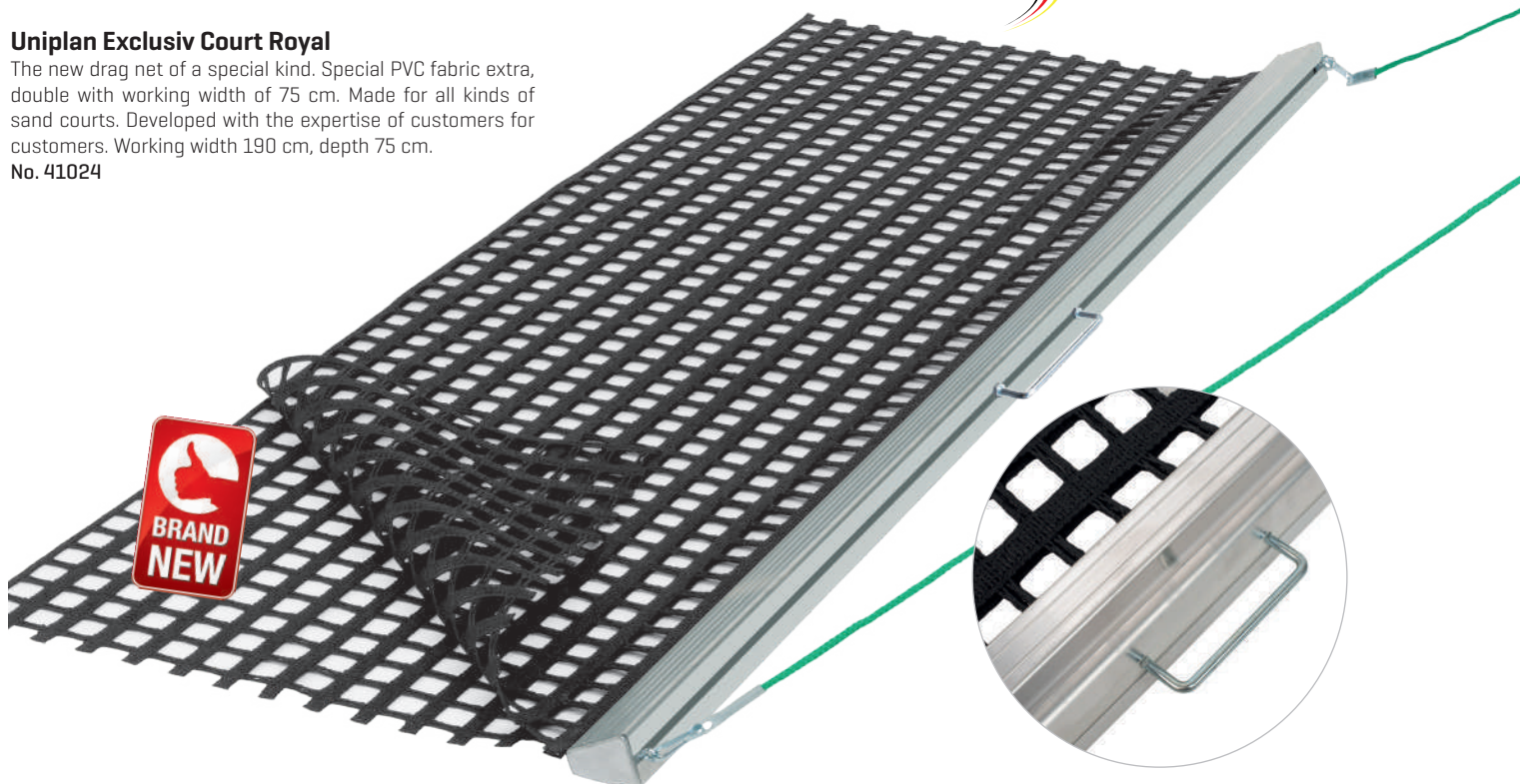

# Maintenance + Care



## Wooden Drag Net, Single PVC

One PVC-coated net 200 x 115 cm, with wooden rail. Suitable for clay and shale courts.

No. 41021



## Wooden Drag Net, Double PVC

Two PVC-coated nets 200 x 115 cm, with wooden rail. Suitable for clay and shale courts.

No. 41020

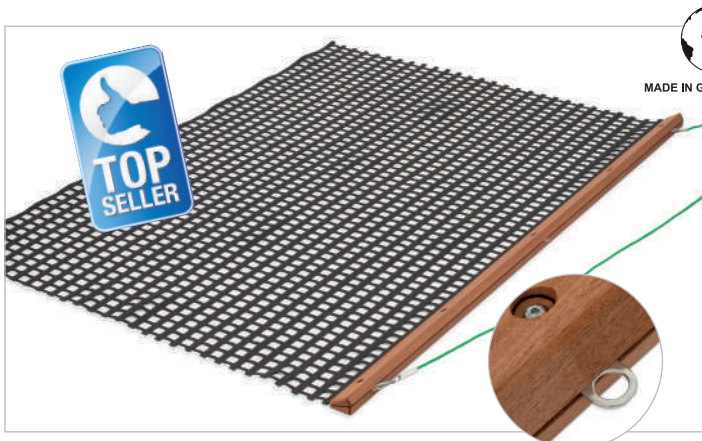

## Wooden Drag Net, Special Single

One special PVC fabric net 200 x 150 cm, with wooden rail. Suitable for clay and shale courts.

No. 41030



## Wooden Drag Net, Special Double

Two special PVC fabric nets 200 x 150 cm, with wooden rail. Suitable for clay and shale courts.

No. 41041

## Aluminum Rail

Width 200 cm, complete with drag cord.

No. 40990



## Wooden Rail

Triangular wood, pre-drilled with screws. 200 cm, complete with drag cord.

No. 40992



Our wooden drag rail are made from torsion-free red pine wood patios. More than 150.000 been produced.



## Pull Handle

Aluminum pull handle compatible with all tennis court brooms, broom-mats and wooden drag nets.

No. 40861



## Drag Cord

3.5 m long with spring hooks.

No. 41002

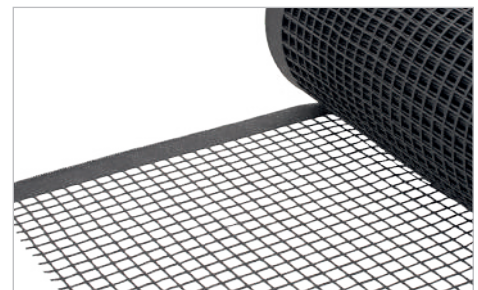

## Drag Net Material PVC

Width 1.15 m. Total length of the roll 130 m. For drag net self-assembly.

No. 41001

No. 410011

per m  
per piece á 2 x 1,15 m

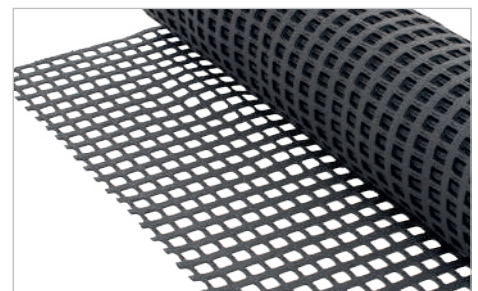

## Drag Net Material Extra

Width 1.50 m. Total length of the roll 30 m (45 sqm), or drag net self-assembly.

No. 41031

No. 410331

sqm  
per piece á 2 x 1,5 m

## Maintenance + Care

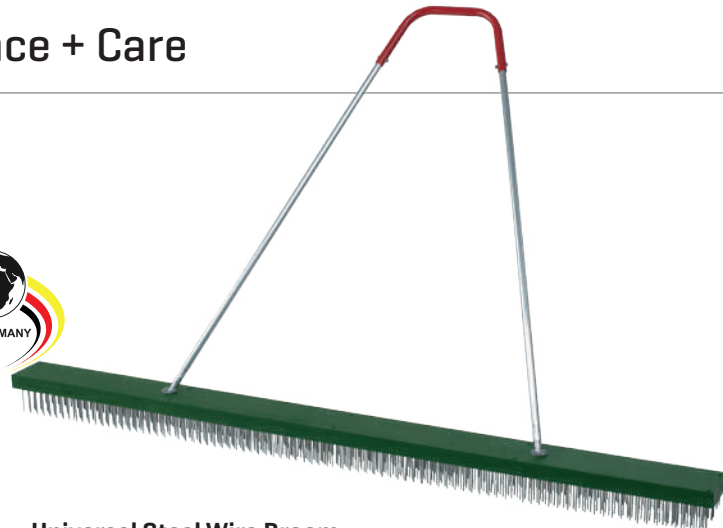
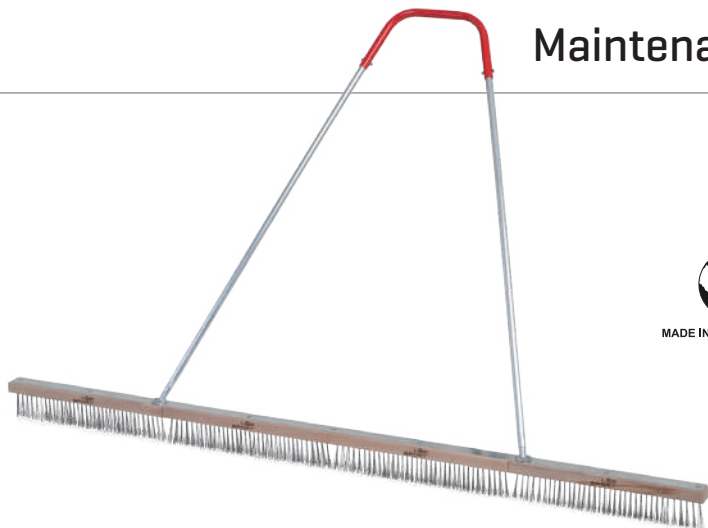

### Universal Steel Wire Broom slim

For scratching the court surface and removing leaves from court. Ideal device for spring, season and autumn. Light design with aluminum rail and drag cord.

200 cm width

No. 40925

**Replacement Broom** 200 cm

No. 40926

### Universal Steel Wire Broom

Roughening of hard and water-impermeable tennis courts. For removing surfaces overgrown with moss. Ideal equipment for the work in spring. Should not be mis-sing on each tennis court. Heavy model including aluminum pulling handle.

No. 40920

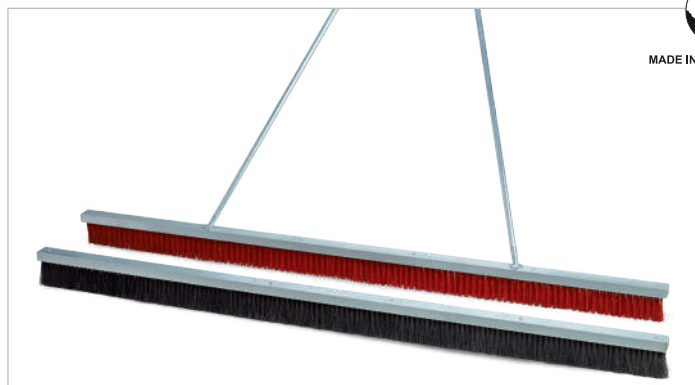

### Tennis Court Broom

With long, narrow bristles. Wide aluminum bracket and frame, 200 cm width.

No. 40943 Plastic

No. 40942 Arenga

### Replacement Brush 200 cm

No. 409430 Plastic

No. 409420 Arenga

### Tennis Court Broom I

With long, narrow bristles. Easy handling due to the adjustable pulling handle. Aluminium frame, 270 cm width.

No. 40950 Plastic

No. 40940 Piassava

### Replacement Brush 135 cm

No. 40970 Plastic

No. 40960 Piassava

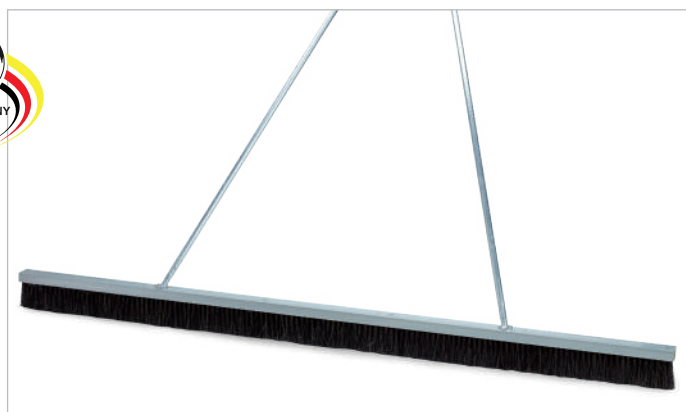
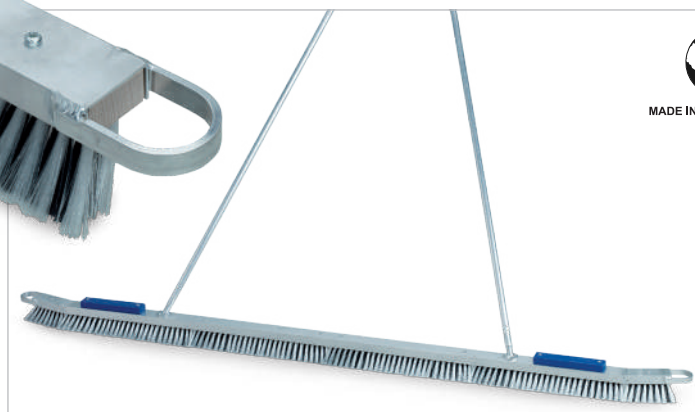

### Granu-Top Broom

This is the perfect broom for cleaning granular surfaces. The bent ends of the broom and the position of the bristles guarantee an even spread of granules. The static supercharge cleans debris abraded from the balls and lint from the surface. Complete with aluminum handle and weights on both ends.

Working width 200 cm.

No. 41076

### Replacement Brush for Granu-Top

No. 410761

### Broom for Granular Surfaces

Broom with Arenga bristles for hall floors with rubber granular. The special position of the bristles guarantees an even sliding of the broom. Complete with a very sturdy aluminum handle in three parts. Working width 200 cm.

No. 41075

## Maintenance + Care

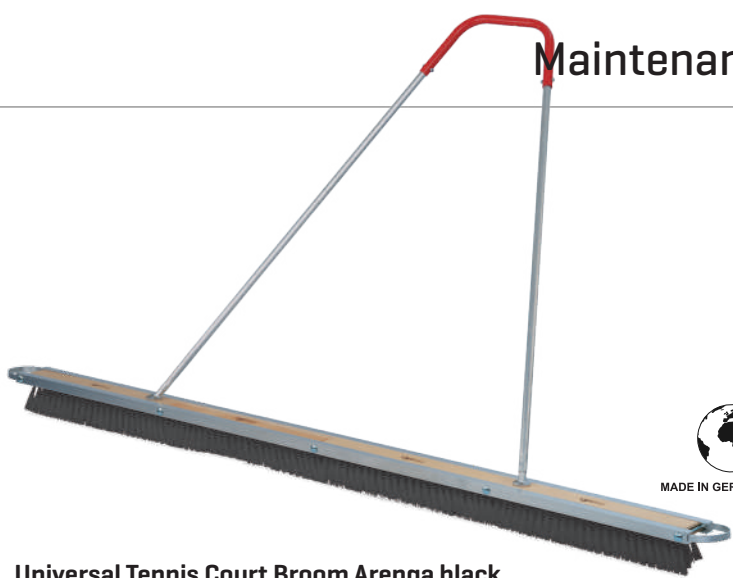

### Universal Tennis Court Broom Arenga black

With four replaceable broom parts in aluminum frame, complete with aluminium pulling handle, 200 cm width.

No. 40870

### Replacement Brush Arenga black

No. 40900 50 cm

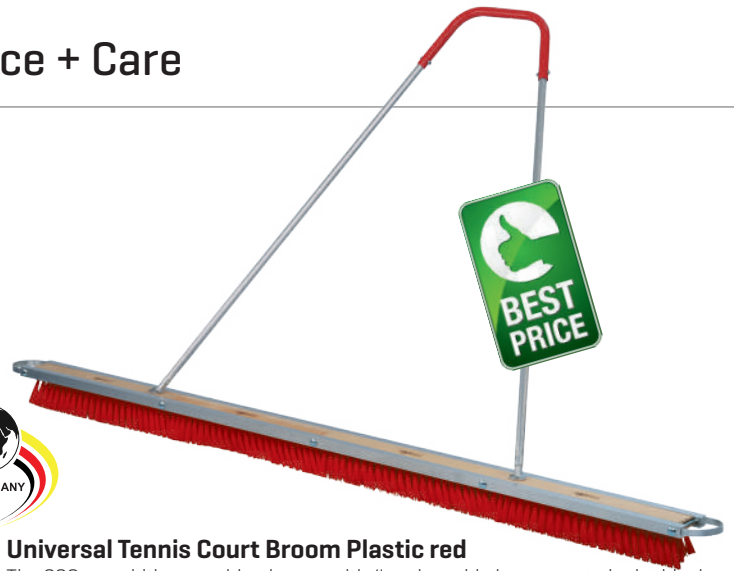

### Universal Tennis Court Broom Plastic red

The 200 cm width smoothing broom with 4 replaceable broom parts is the ideal maintenance device for clay courts. The aluminum base frame has net guards on each side. Complete with a two-part, sturdy aluminium pulling handle.

No. 40860

### Replacement Brush Plastic red

No. 40890 50 cm

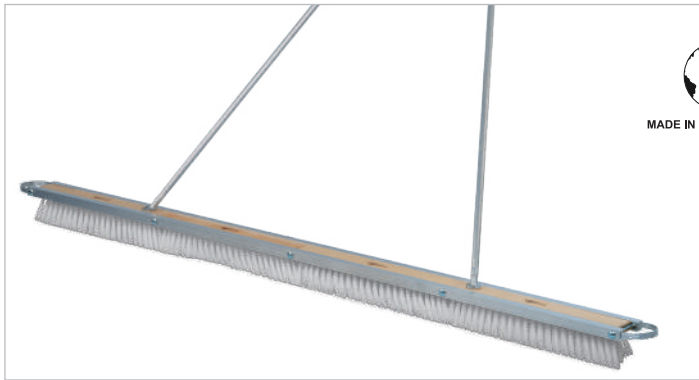

### Universal Tennis Court Broom Plastic white

Smoothing broom with 4 replaceable broom parts is the ideal maintenance device for clay courts. The aluminum base frame has net guards on each side. Complete with a two-part, sturdy aluminium pulling handle, width 200 cm.

No. 40865

### Replacement Brush Plastic white

No. 40864 50 cm

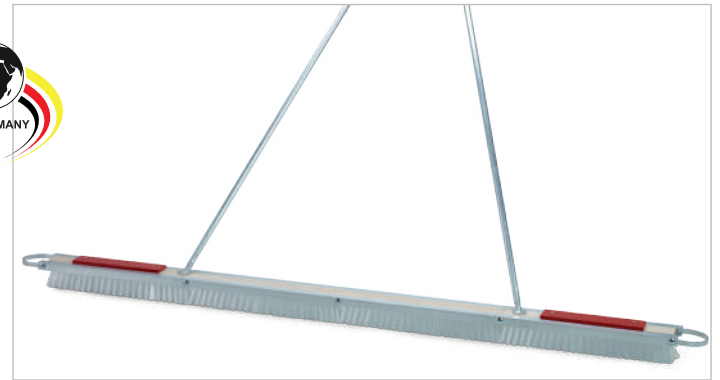

### Tennis Court Broom Special

Four replaceable plastic broom parts in aluminum frame, two additional weights to stop the broom from hopping or jumping, 200 cm width. Complete with aluminium pulling handle.

No. 40862

### Replacement Brush Special

No. 40864 50 cm

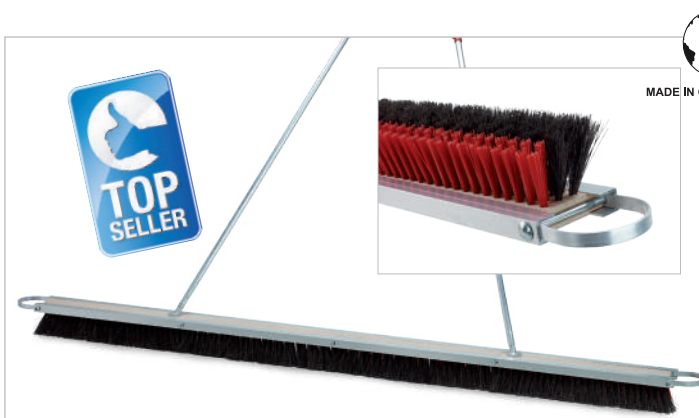

### All-Weather Smoothing Broom

The newly developed 200 cm width smoothing broom with 4 replaceable broom parts is the ideal maintenance device for clay courts. The brush section consists of two rows of plastic bristles and three rows of Arenga bristles. The plastic bristles at the front loosen the material, the Arenga bristles at the rear distribute the loosened material evenly over the court. The aluminum base frame has net guards on each side. Complete with a two-part, sturdy aluminium pulling handle.

No. 40935

### Replacement Brush

No. 40936 Plastic / Arenga 50 cm

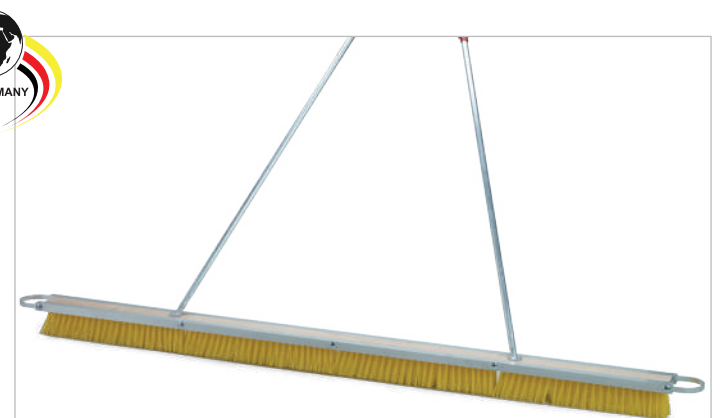

### Tennis Court Broom for Quartz Sand Plastic yellow

The Smoothing Broom with 4 replaceable broom parts is the ideal maintenance device for quartz sand courts. The aluminum base frame has net guards on each side. Complete with a two-part, sturdy aluminium pulling handle, width 200 cm and yellow plastic bristles.

No. 40881

### Replacement Brush Plastic yellow

No. 40883 50 cm

# Maintenance + Care



## Line Brush TOP

Sturdy plastic-coated aluminium handle with joint. Brush with high-quality bristles.

No. 41134 Arenga [soft]

No. 41137 Plastic [hard]

## Replacement Brush TOP

No. 41135 Arenga [soft]

No. 41138 Plastic [hard]



## Line Brush I without handle

No. 41100 Plastic

No. 41110 Arenga

## Wooden Handle

Ø 24 mm, length 1,5 m.

No. 40091

## Aluminum Handle ROYAL

No. 41128

## Wooden Handle ROYAL

No. 41129



## Hand Broom ROYAL

Molded plastic body with low-wear bristles. Exclusive model with joint made of environmentally friendly recycled plastic. The ideal line broom with long durability.

No. 41113 without handle

## Wooden Handle for ROYAL

No. 411132

## Aluminum Handle for ROYAL

No. 411131

# Maintenance + Care

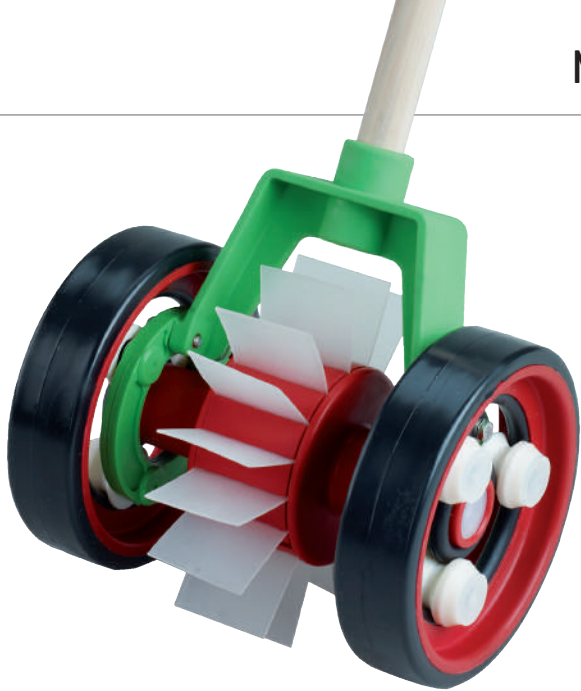

## Line Master

This new line cleaning machine is the best-seller in the USA. The friction-wheel drive, powered by the solid rubber wheels, pins the plastic brush to clean lines quickly and easily. Robust aluminum case with ergonomically shaped handle. No. 41087



## Line Lightning Sweeper

Perfected, well-designed line cleaner for all surfaces, especially clay, shale and rubber granule surfaces. All parts replaceable. Without handle.

No. 41081

## Replacement Sweeper Blades

No. 41084

## Replacement Rolls

No. 41085

## Replacement O-ring set of four

No. 41086

## Bracket

No. 41088

## Replacement Wheels set of two

No. 41089



## Match Liner

This line sweeper is unsurpassed in price and handling. Well thought-out, smooth-running construction made of weather-resistant and abrasion-resistant materials. When the drive wheels roll, the brush is driven in the opposite direction, ideal for all types of tennis lines. Without a handle. Brush width 4 cm and 5 cm

No. 41082 4 cm

No. 41092 5 cm

## Replacement Brush

No. 41083 4 cm

No. 410921 5 cm

Handle 24 mm

No. 40091

# Maintenance + Care

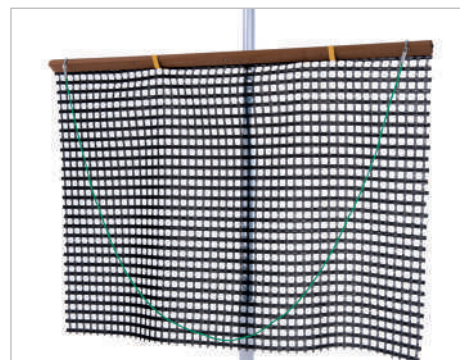

## Drag Net Double Holder

The newly developed double drag net holder for ideal storage of smoothing and drag nets. Made of aluminum tubing with two hooks and a fixing bracket for fence posts with  $\varnothing$  60 mm. The holder is coated in yellow plastic and therefore easily visible.

No. 41434



## Tool Holder

Zinc-plated steel, fixing bracket with standard hook. To hang brooms, drag nets and smoothing mats.

No. 41430  $\varnothing$  45 mm  
No. 41440  $\varnothing$  60 mm



## Drag Net Holder

Made of galvanized flat iron, 3 mm thick, includes fixing materials for trouble-free assembly on fence post.

No. 41443



## Handle Holder

For line brushes and all other equipment with a broom handle diameter of 23-28 mm. The rubber holder holds the handle securely. The holder can be easily attached to a fence post with  $\varnothing$  60 mm, by using clamps.

No. 414321



## Tool Holder EXTRA

Fixing clamp with rubber lining. Does not damage fence posts. All steel parts zinc-coated. For brooms, drag nets and smoothing mats. For fence post with 60 mm  $\varnothing$ .

No. 41435



## Tool Holder

Fixing clamp with 1 hook. For brooms, drag nets and smoothing mats. Made of zinc-coated steel, for fence post with 60 mm  $\varnothing$ .

No. 41431



## Hand Brush Holder

Fixing bracket with 2 hooks for hanging hand brushes. Made of steel, for fence post with 60 mm  $\varnothing$ .

No. 41433

# Maintenance + Care

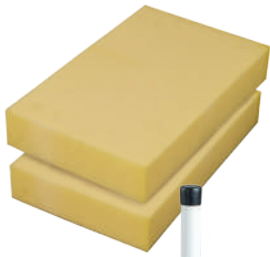

**Tennis Court Drying Sponge**  
To soak up smaller puddles on the court.  
Dimensions:  
50 x 80 x 8 cm  
No. 41155



**Tennis Court Drying Set**  
Bucket with galvanised grid plate and sponge with aluminum handle. To soak up small puddles on the court.  
No. 41182



**Scissor roller**  
aluminum scissor handle.  
- Length including roller body approx. 1440 mm  
- Total width below approx. 520 mm  
- Width of the roller body 500 mm  
- Handle width above approx. 520 mm  
- Weight 4 kg  
[Technical changes reserved]  
No. 411855



**Water Roller**  
Foam rubber roller with handle. To clear puddles from hard courts, 90 cm wide. All metal parts galvanised.  
No. 41180

**Spare Roller for Water Roller**  
No. 41181



**Universal Absorbing Roller Special**  
Absorbing drum with foam rubber covering, hot-galvanised frame and drum body. Thanks to the huge absorbent capacity of this roller it is possible to make a court playable again in a very short period of time. Working width 80 cm.  
No. 41141

**Replacement Absorbing Drum**  
No. 41150

**Replacement Sponge with adhesive**  
No. 41151



**Rubber Squeegee "Dry Court"**  
Made of aluminum, 145 cm wide, replaceable rubber blade, 2 durable wheels in front. Easy and convenient for water removal and ball collection. Works especially well around pools, on driveways, golf greens and any flat or hard surfaces. Comes with one blade for replacement.  
No. 41183

**Replacement Rubber Blade**  
No. 41184



## Maintenance + Care



### Full-circle Sprinkler

Large surface sprinkler with a circle diameter of 32 m, thus sprinkling a total area of 800 sqm. Connection 3/4". Without tripod.

No. 41322



### Part-Circle and Full-Circle Sprinkler

Large surface sprinkler with a circle diameter of 32 m, thus sprinkling a total area of 800 sqm. Working area can be adjusted from 20° to 340°, or full-circle. Connection 3/4". Without tripod.

No. 41321



### Folding Tripod

Specially developed for the tennis court. Large foot disks prevent damage to the court surface. Folding mechanism makes it easy to handle and to store in small places. Suitable for all types of sprinklers in our catalog.

No. 41323



### Circular Sprinkler

Large-area sprinkler with a circle diameter of 32 m, thus sprinkling a total area of 800 sqm. Without tripod.

No. 41320



### Perrot - Turbo Quadrilateral Sprinkler

Triton SW

Single-jet oscillating lever sprinkler with hot-dip galvanized steel housing, galvanized steel-plastic coated perimeter plate and impact- and break-resistant plastic housing cover. 22° stream rise and stream disrupter to vary the throw side and water distribution. Polyamide guide housing with brass stabilization.

No. 41331

### Coverage for In-Ground Sprinkler

No. 41332

### Inlay In-Ground Sprinkler

No. 41333

# Maintenance + Care

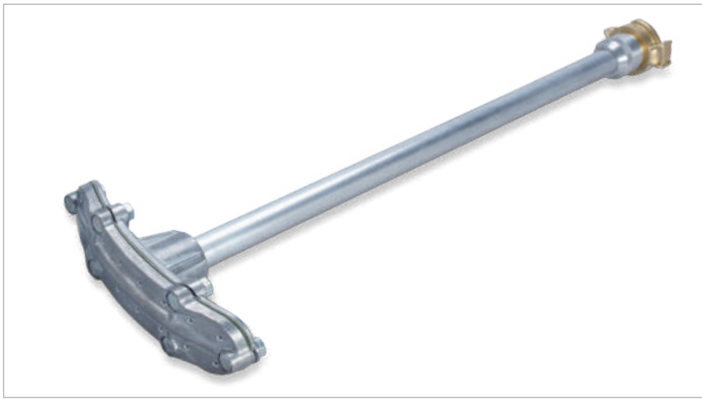

## Spray Nozzle

Large nozzle sprinkles evenly over large areas. Complete with Geka connection and tube.

No. 41340



## Spray Nozzle with Shut-Off Valve

Large nozzle sprinkles evenly over large areas. Complete with Geka connection and tube. With shut-off valve.

No. 41350

## Adjustable Nozzle

Made of light alloy metal with hard PVC steel tube. Metal ball valve lever and spray adjuster. Jet length approx. 15 m. Complete with Geka connection.

No. 41361



## Pistol Spray Nozzle

Large nozzle sprinkles evenly over large areas. With a pistol grip. Optimum adjustment of sprinkling with shut-off device.

No. 41360



## Water Hose Special

Quality hose, especially for tennis courts, resistant to low temperatures. Flexible, compression-proof, weatherproof. Available in 50 m lengths.

No. 41371 3/4"

No. 41381 1"

## Water Hose

Especially for tennis courts and sports grounds, green. Available in 50 m lengths.

No. 41370 3/4"

No. 41380 1"



No. 41403

No. 41391

No. 41402

## Geka adapters, brass

No. 41391 3/4"

No. 41401 1"

## Connectors, brass with Geka

No. 41402 3/4"

No. 41404 1"

## Hose clip set of 10 pieces

For water hose up to 2"

No. 41403

## Gaskets for Geka

set of 10 pieces

No. 41342

## Gaskets for internal thread

set of 10 pieces

No. 41405 3/4"

No. 41406 1"

## Gaskets for spray nozzle

set of 5 pieces

No. 41341



## Motor Roller USP III - new generation

The USP tennis court roller in a proven design and quality with a new casing, improved once again. With two-part roller body with differential for better turning of the roller. The mechanically turned roller body characterizes this USP motorized roller. The 900 mm wide trailing roller prevents the roller from sinking into the tennis surface. Better noise insulation and the biodegradable hydraulic oil are second to none.

### Technical data:

Motor: Honda GX 160, 4-stroke engine 4,0 kW = 5.5 HP at 3600 U/min.  
 Fuel/oil: unleaded regular petrol / with biodegradable hydraulic oil!  
 Drive: hydraulic drive  
 Roller: two-piece, 900 mm wide, with differential, diameter Ø 500 mm  
 Speed: infinitely adjustable to approx. 5 km/h, forward and reverse

Working width: 900 mm  
 Weight: empty ca. 350 kg, full ca. 480 kg  
 Dimensions: length: 1800 mm, width: 985 mm, height: 1100 mm

## Motor Roller USP III - new generation No. 40136 Tennis court roller



## Motor Roller Zagro FUTURA - Self-Driving

Mount motor roller with a swivelling seat, rubber-coated, broad drive front wheel, split roller body with compensation differential for high maneuverability. Simple and easy rolling on the tennis courts.

### Technical data:

Motor: Honda GX 160, 4-stroke engine 4,0 kW at 3600 U/min.  
 Fuel: unleaded gasoline  
 Drive: hydraulic drive  
 Roller: single-piece or split; width 900 mm, Ø 508 mm  
 Speed: infinitely adjustable to approx. 6 km/h, forward / reverse

Working width: 900 mm  
 Weight: empty ca. 380 kg, full ca. 510 kg  
 Dimensions: length: 1800 mm, width 990 mm, height: 1050 mm  
 No. 40152



## SANDY II – Tennis Sand Spreader

The new SANDY II was checked fundamentally and it makes the new sanding of the spring maintenance much more effective. Two helpers for the supply and half an hour time are sufficient in order to be able to spread the clay carpet like sand evenly distributed in one operation. SANDY II is easy to operate by hand and it is able to take a maximum volume of ca. 120 clay. With its size of ca. 1000 x 500 x 600 mm it is very handy and has got an ideal weight of 50 kg. The working size is 990 mm.

The functional device for spreading clay was developed by experts and has been proven effectively on various courts. Even on uneven ground you get a completely smooth surface, which only has to be machined with a dragnet.

No. 40142



## Clay Court Cutter USP 10

It actually borders on witchcraft when you find out at what time and with what precision spring overhauls are now carried out with this special milling machine. Until now, groundskeeper and members had to laboriously remove the used brick dust by hand. Often too little material was removed. Tennis court surfaces were getting thicker and more impermeable. With the USP 10 tennis court milling machine, these problems are easily solved! The exact height adjustment is done by hand with 2 wing screws. It can be done independently on both sides. With this device, the milling depth can be determined with millimeter precision. The milled material is ejected in strips and can be shoveled into wheelbarrows with little effort. The power of the 5.5 HP Honda motor ensures that the work with the USP 10 tennis court milling machine is absolutely even, so that the courts remain level or become flat again. Thanks to a comprehensive service network, the maintenance and repair of the quietly running engine is guaranteed everywhere. The USP 10 tennis court milling machine rolls at the front on 2 independently mounted roller bodies. As a result, the pressure is evenly distributed so that it hardly sinks in, even when the places are defrosted in spring. The rear, profile-free solid rubber wheels and the low weight make the device extremely agile and mobile. The USP 10 tennis court milling machine fits through any access door and can easily be operated by one person.

### Technical Data:

Length:	approx. 800 mm
Width:	approx. 850 mm
Height:	approx. 1000 mm
Cutting width:	approx. 655 mm
Weight:	approx. 75 kg
Motor:	Honda, 4-stroke, 4 kW/5.5 PS

No. 40140

## Manual Roller I Special

For tennis courts and sports grounds. Working width 90 cm, empty weight 60 kg, water filled 180 kg. Single-piece roller body with rounded edges and counter weights.

No. 40170

## Manual roller I

Like article No. 40170, but without counter weights.

No. 40171

## Manual roller II Special

Like article No. 40170, but with a split roller body which makes it easier to turn.

No. 40180

## Manual roller II

Like article No. 40180, but without counter weights.

No. 40181

# Maintenance + Care

## Turbo Broom USP 10

The Turbo Broom USP 10 makes it easier to remove the old clay in spring. Through the low empty weight, the broom can be moved effortlessly. The V-belt drive enables a left/right run, which makes it possible to remove the corners of the tennis court neatly. The Turbo Broom USP 10 is variously usable, so it is also possible to use that machine to remove leaves and snow from paths and car parks.

Technical data:



### Technical data:

Motor:	Honda, 4-stroke, 4 kW/5 PS
Drive	by hand
Sweeping broom drive:	V-belt drives left/right
Working width:	ca. 90 cm
Tyres:	balloon tyres
Weight:	65 kg
Time requirement:	ca. 40 min. per court

No. 40161

### Accessories

- No. 40165 PVC bristles, double, white (without illustration)
- No. 40164 Steel/PVC bristles
- No. 40162 Swath former



### Accessories

- No. 40145 PVC bristles (standard equipment), yellow
- No. 40147 Steel bristles
- No. 40148 Swath former

## Nets + Accessories



## Advantage for ROYAL Tennis Nets

With our COURT ROYAL brand, we have been one of the world's leading manufacturers of high-quality tennis nets for all levels of ability, from club sports to international ATP professional tournaments, for over 38 years. Our nets are exclusively hand-knotted and, with the associated elasticity, offer above-average durability. In addition the nets offer an optimal bounce off behaviour. All tennis nets from our large range are supplied with steel ropes, have the seal for „tested safety“ and meet the strict requirements of DIN EN 1510.



# Nets + Accessories

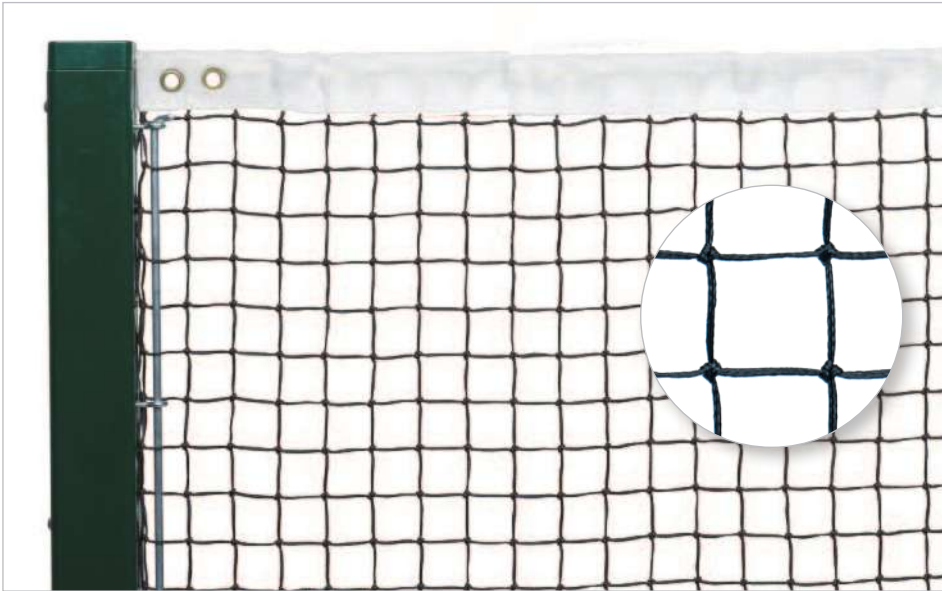

## Tennis Net Court Royal TN 8

Made of 3.2 mm braided polyethylene, black, hand-knotted, black, stable polyester net enclosure stitched four times, complete with steel wire. DIN EN 1510. With European Seal of Approval. No. 40549 black

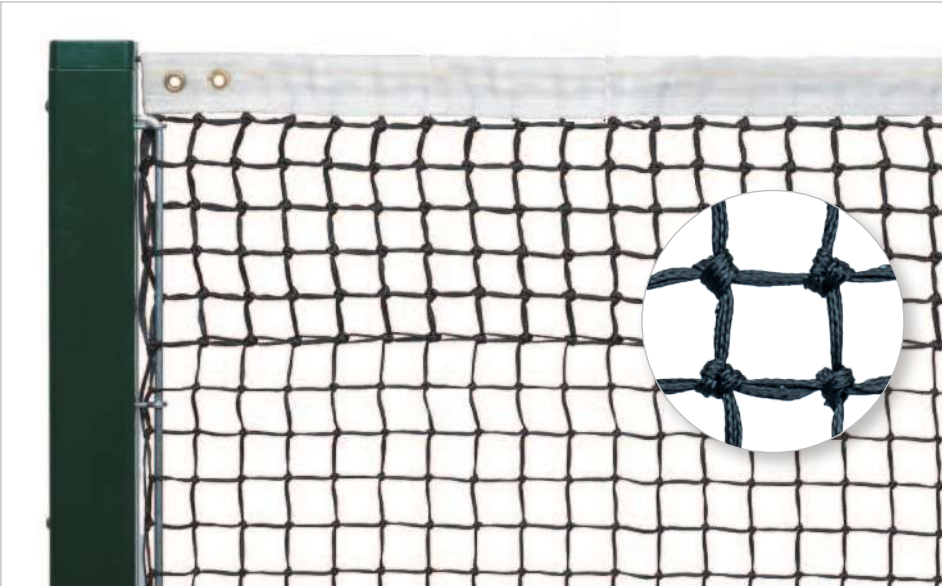

## Tennis Net Court Royal TN 15 black

Made of 3.2 mm braided polyethylene, black, hand-knotted, the upper 6 rows double-knotted, stable polyester net enclosure stitched 4 times. A super tennis net, long-lasting, good quality. Complete with steel wire. DIN EN 1510. With European Seal of Approval. No. 40550 black



## Tennis Net Court Royal TN 20 black

Made of 3.4 mm braided polyethylene, black, hand-knotted, the upper 6 rows double-knotted, stable polyester net enclosure stitched four times. 1000 times proven, classic tennis net. Used in the tennis league, ATP-tournaments, Davis-Cup, as well as in the Olympics. A top-class product. Complete with steel wire. 2 years factory warranty on the netting. DIN EN 1510. With European Seal of Approval. No. 40560 black

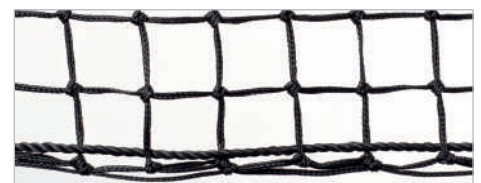



# Nets + Accessories

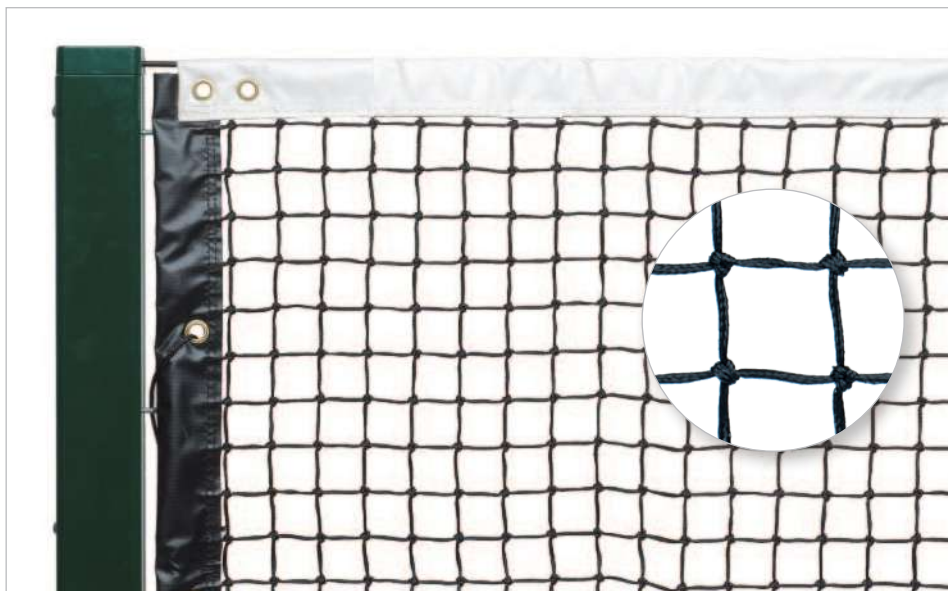

## Tennis Net Court Royal TN 9

Made of 3.4 mm braided polyethylene, hand-knotted, black, stable polyester net enclosure stitched 6 times, complete with plastic-coated steel cable. Sides and bottom with heavy, black plastic edging as well as two 10 mm strong fiberglass rods for lateral fixing. Long-lasting and very durable. 3 years factory warranty on the netting. DIN EN 1510. With European Seal of Approval.

No. 40545 black



## Tennis Net Court Royal TN 15 green

Made of 3.2 mm braided polyethylene, green, hand-knotted, the upper 6 rows double-knotted, stable polyester net enclosure stitched 4 times. A super tennis net, long-lasting, good quality. Complete with steel wire. DIN EN 1510. With European Seal of Approval.

No. 40552 green



## Tennis Net Court Royal TN 20 green

Made of 3.4 mm braided polyethylene, green, hand-knotted, the upper 6 rows double-knotted, stable polyester net enclosure stitched four times. 1000 times proven, classic tennis net. Used in the tennis league, ATP-tournaments, Davis-Cup, as well as in the Olympics. A top-class product. Complete with steel wire. 2 years factory warranty on the netting. DIN EN 1510. With European Seal of Approval.

No. 40570 green

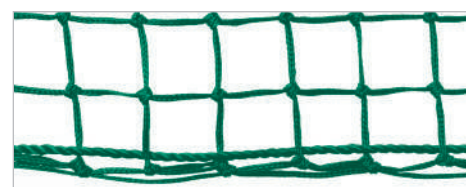

## Nets + Accessories



### Tennis Net Court Royal TN 90 black

Made of 3.8 mm braided polyethylene, hand-knotted, the upper 6 rows double-knotted, stable polyester net enclosure stitched four times, complete with plastic-coated steel cable. Sides and bottom with heavy, black plastic edging, as well as 10 mm strong fiberglass rods for lateral fixing. Long-lasting and very durable. A tennis net in a special class. 3 years factory warranty on the netting. DIN EN 1510. With European Seal of Approval.

No. 40610 black



### Tennis Net Court Royal TN 30

Made of 3.8 mm braided polyethylene, hand-knotted, the upper 7 rows double-knotted, stable polyester net enclosure stitched 6 times, complete with plastic-coated steel cable. Sides and bottom with heavy, black plastic edging as well as two 10 mm strong fiberglass rods for lateral fixing. Long-lasting and very durable. 3 years factory warranty on the netting. DIN EN 1510. With European Seal of Approval.

No. 40548 black



### Tennis Net Court Royal TN 50 Tournament

Made of 3.5 mm braided polyethylene. Hand-knotted, the upper 7 rows double-knotted, very stable polyester net enclosure stitched four times. Complete with plastic-coated steel cable. 2 years warranty on the netting. Mesh size 4 cm, prevents balls becoming stuck in the net. DIN EN 1510. With European Seal of Approval.

No. 40565 black

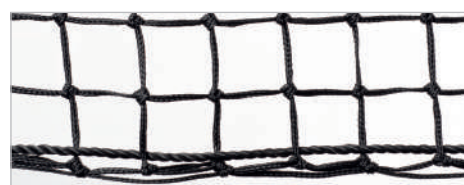

# Nets + Accessories



## Tennis Net Court Royal TN 90 green

Made of 3.8 mm braided polyethylene, hand-knotted, the upper 6 rows double-knotted, stable polyester net enclosure stitched four times, complete with plastic-coated steel cable. Sides and bottom with heavy, black plastic edging, as well as 10 mm strong fiberglass rods for lateral fixing. Long-lasting and very durable. A tennis net in a special class. 3 years factory warranty on the netting. DIN EN 1510. With European Seal of Approval.

No. 40611 green

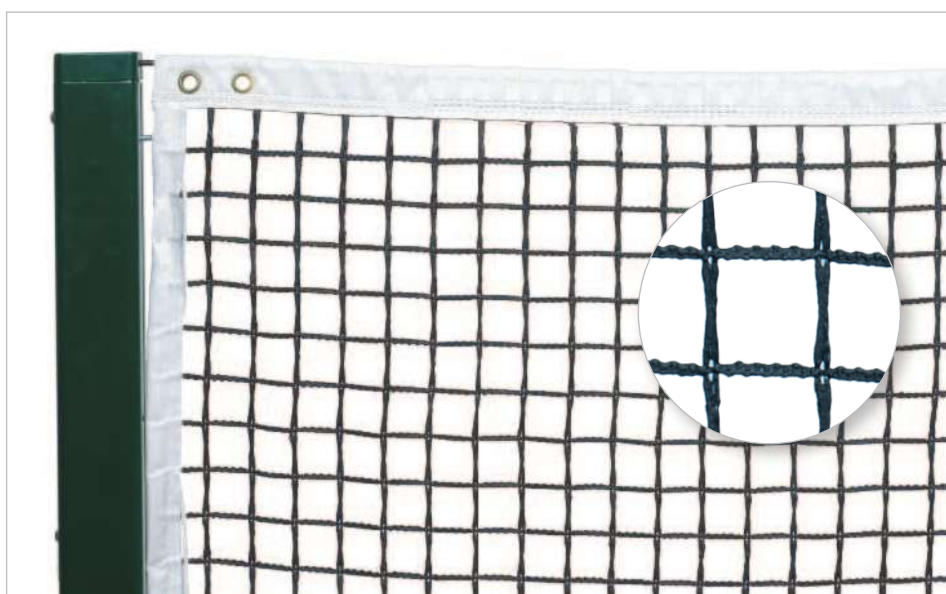

## Deluxe Tennis Net Court Royal TN 200

Made of approx. 5 mm polyester fabric with a black plastic cover. Stable edging with steel cable. Very long life. An almost indestructible tennis net. 5 years factory guarantee on the mesh fabric. GS-tested according to DIN EN 1510.

No. 40580 black



## Tennis Net Court Royal TN 55 Tournament Singles

Made of 3.5 mm braided polyethylene. Hand-knotted, the upper 7 rows double-knotted, very stable polyester net enclosure stitched four times. Complete with plasticcoated steel cable. 2 years warranty on the netting. Mesh size 4 cm, prevents balls becoming stuck in the net. DIN EN 1510. With European Seal of Approval.

No. 40566 black



# Nets + Accessories



## Tennis Net Post Court Royal TP 83

Round post, Ø 83 mm. Special reinforced aluminum profile with groove for fastening the net holding rod. Internal trapeze tensioning mechanism with an aluminium key for easy net tensioning. Clip-on cap made of cast aluminum including safety chain. Overall length of posts: 142 cm. Weight: 10.5 kg. Aluminium ground sleeves, depth of insertion 35 cm, complete with cast aluminium cover. Meets the European DIN EN 1510 safety standard.

**No. 404001** aluminum anodized  
**Delivery without ground sleeves**

**Ground sleeves with cover**  
round sleeves made of aluminum, insertion depth 35 cm, complete with cast aluminum cover. GS tested according to DIN EN 1510.  
**No. 404011**

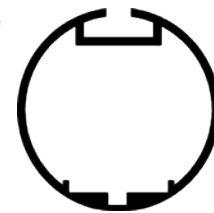

**No. 404101** green powder-coated  
**Delivery without ground sleeves**



**No. 404111** white powder-coated  
**Delivery without ground sleeves**



**No. 404471** black powder-coated  
**Delivery without ground sleeves**

# Nets + Accessories



## Tennis Net Post Court Royal TP 80

Square post, 80 x 80 mm. Special reinforced aluminum profile with groove for fastening the net holding rod. Internal trapeze tensioning mechanism with aluminum key for easy net tensioning. Clip-on cap made of cast aluminum including safety chain. Overall length of posts: 142 cm.

Weight: 10.5 kg. Aluminum ground sleeves, depth of insertion 35 cm, complete with cast aluminum cover. Meets the European DIN EN 1510 safety standard.

**No. 404301** aluminum anodized  
**Delivery without ground sleeves**

### Ground sleeves with cover

Ground sleeves made of aluminum, insertion depth 35 cm, complete with cast aluminum cover. GS tested according to DIN EN 1510.

**No. 404311**

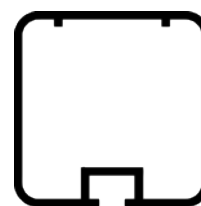

**No. 404401** green powder-coated  
**Delivery without ground sleeves**



**No. 404451** white powder-coated  
**Delivery without ground sleeves**



**No. 404461** black powder-coated  
**Delivery without ground sleeves**

**No. 404481** blue powder-coated  
**Delivery without ground sleeves**

## Nets + Accessories



### Tennis Net Post Alu TP 73

Round post  $\varnothing$  73 mm made of green plastic-coated aluminum. Special profile with three compartments, very sturdy with screw-on gear wheel mechanism of aluminum. Net holding rod and all screws and hooks are made of VA steel. Delivery without ground sleeves.

No. 40422



### Tennis Net Post Steel TP 76

Round post  $\varnothing$  76 mm made of green plastic-coated steel pipe with screw-on aluminum gear wheel mechanism with brass rope castors. Removable crank, net-holding straps and net hooks fully welded. Delivery without ground sleeves.

No. 40427



### Ground Sleeves 73

Ground sleeves for 73  $\varnothing$  mm post

No. 404281

### Ground Sleeves 76

Ground sleeves for 76  $\varnothing$  mm post.

No. 40428



### Tennis Net Post USA, Steel 76

76 mm  $\varnothing$  galvanized steel, green powder-coated. With brass gear mechanism, stringing block and a removable crank. Ground sleeves not included. Meets the European DIN EN 1510 safety standard.

No. 40425



### Tennis Net Post USA, Steel 80

80 x 80 mm galvanized steel, green powder-coated. With brass gear mechanism, stringing block and a removable crank. Ground sleeves not included. Meets the European DIN EN 1510 safety standard.

No. 40424



### Ground Sleeves 76

Ground sleeves for 76  $\varnothing$  mm post.

No. 40428

### Ground Sleeves 80 x 80

Ground sleeves for 80 x 80 mm post.

No. 404311





**Collapsible Tennis Net Post  
Court Royal**

This tennis net post can be folded down and is used when there is not enough depth for ground sleeves. The attachment is made with a 10 mm steel dowel and a screw. The 80 x 80 mm aluminum post is held by a support to the front on the hot-dip galvanized base console. The execution corresponds to our tennis post Court Royal.  
No. 40470

**Special adapter for tennis net posts**

for which no standard post fits?

Then the adapter is the perfect solution. Please indicate the diameter of the ground sleeves and the insertion depth. You can choose any post from our production - round or square - aluminum or colored powder-coated. Suitable for the articles: 404001 / 404101 / 404111 / 404471 / 404301 / 404401 / 404451 / 404461 (page 36 and 37)  
NO. 404801



**Mechanics made of Brass 76**

for Tennis Net Post USA Steel 76, complete with fastening screws.  
No. 404251

**Mechanics made of Brass 80**

for Tennis Net Post USA Steel 80, complete with fastening screws.  
No. 404241



**Crank made of Brass**

for mechanics Tennis Net Post USA Steel 76 und 80.  
No. 404242

**Crew made of Brass**

for crank Tennis Net Post USA Steel 76 und 80.  
No. 404243



**Mechanic for Tennis Posts**

This winding gear mechanism can be attached with 2 M8 screws at each post. Holes pre-drilled and M8 thread cut.  
No. 40429





### Spare parts for tennis net posts

**1 Ground sleeve 80 x 80 mm**

No. 40431

**2 Ground sleeve 83 mm Ø**

No. 40401

**3 Cover for Ground sleeve 80 x 80**

No. 40450

**4 Cover for Ground sleeve 83 Ø**

No. 40420

**5 Tensioning mechanism**

No. 40405

**6 Key for tensioning mechanism**

No. 40404

**7 Net holding rod**

No. 40402

**8 Set of screws, eight eye bolts, eight groove sliding blocks and two net hooks**

No. 40403

**9 Cap for blind post 80 x 80**

No. 40416

**10 Cap for mechanism post 80 x 80 mm**

No. 40415

**11 Cap for blind post 83 mm Ø**

No. 40407

**12 Cap for mechanism post 83 mm Ø**

No. 40406

**13 Net repair cord 20 m, 3 mm**

No. 40653 Poly black

**14 Net repair cord 20 m, 3 mm**

Nr. 40654 Poly green

**Ground sleeve 76 mm Ø**

Nr. 40428

[without illustration]

# Nets + Accessories



### Center Strap I

Made of cotton fabric, with brass eyes.  
No. 40700



### Center Strap II

Made of PVC, with adjustable loops and spring hooks.  
No. 40710



### Center Strap III

With plastic snap lock, spring hook and Velcro strip.  
No. 40720



### Center Strap IV

With Velcro closure.  
No. 40711



### Universal Center Strap

Made of high-strength nylon with stainless steel buckles and special hooks.  
No. 40690



### Replacement Tennis Net Headband

Fast to replace, complete with looping string.  
No. 40670



### Center Strap II T

Made of nylon with adjustment loops, without snap hooks.  
No. 407101



### Court Center Strap

Made of high-strength nylon with stainless steel buckles and special hooks.  
No. 40680

# Nets + Accessories



**1 Tennis Net Weight**

Made of steel pipe with suspension eye for strap.  
No. 40721

**2 Ground Anchor I**

Made of stainless steel.  
No. 40740

**3 Ground Anchor Submerged Tube**

Made of aluminum for indoor and all-weather courts. No. 40760

**4 Tensioning Screw**

Made of galvanized iron, with counter nut.  
No. 40730

**5 Ground Anchor Special**

Steel wire with 3 mm eye loop for attachment.  
Anchors when secured in the ground.  
No. 40751

**6 Ground Anchor II**

Galvanized to hammer in, easy to use.  
No. 40750

**7 Ground Anchor III**

U-shaped, galvanized.  
No. 40755



**Replacement Wire with loops**

13.80 m long.  
No. 40660

**Single Net Rods** To use for single tournament games, made of aluminum.

- No. 40650 unpainted
- No. 40649 white
- No. 40648 green
- No. 40655 black



## Nets + Accessories



Used in an aircraft hangar at the official ATP Tennis Tournament in Berlin, in July 2020.



### Tennis Net System Court Royal II Tournament

This newly developed tennis net system is a unique top-class product; it differs from conventional systems through simple modification from double court measurements to single court measurements. Will be delivered in 5 parts. For single court usage the middle part has to be removed and a single net has to be mounted. Delivery is without net, single net rods and center strap. Here we recommend tennis net Court Royal TN 50 No. 40565 (page 28) for doubles and tennis net Court Royal TN 55 No. 40566 (page 29) for single as well as Center Strap II No. 40710 (page 34), weight: 165 kg.

No. 40485 white

No. 404851 black



# Nets + Accessories



**Tennis Net System Court Royal modified for single matches**



**Additional Weights for ATP, WTA and Davis-Cup**

No. 404901 [1 set has 4 weights à 10 kg]

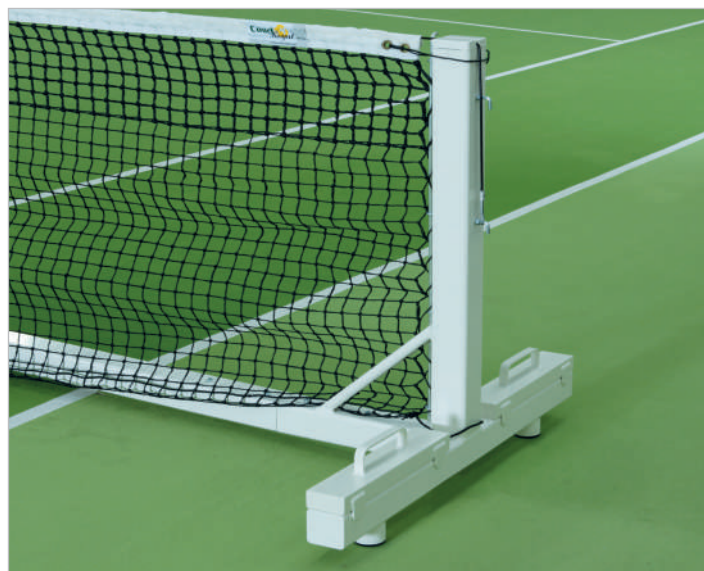

**Tennis Net System Court Royal with mounted weights**

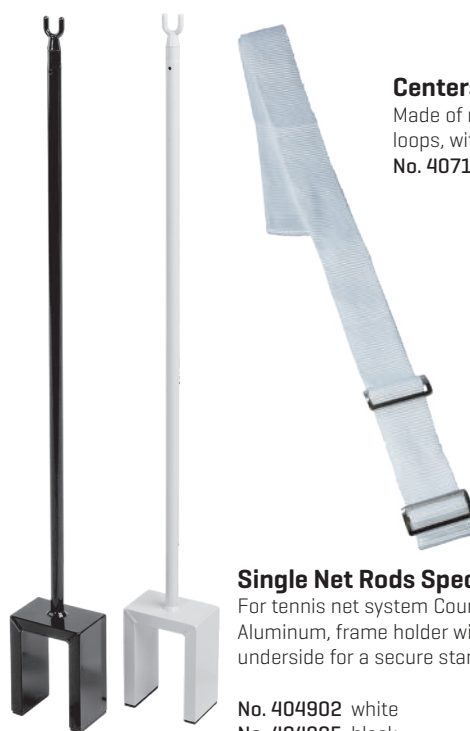
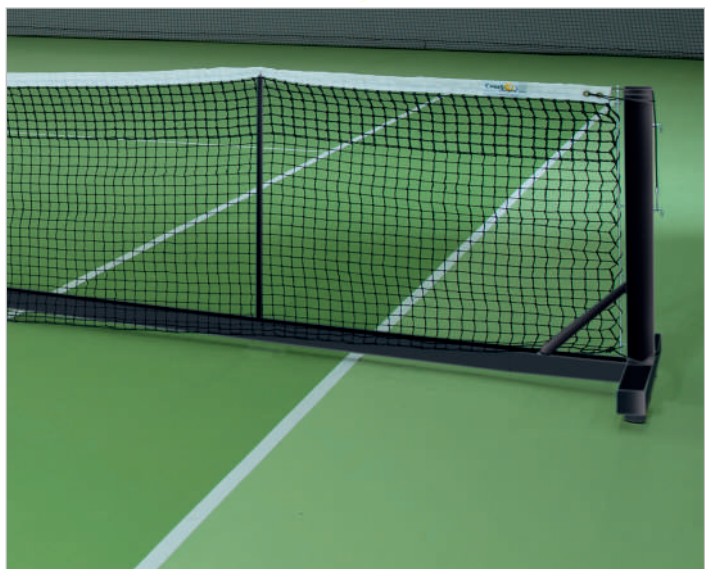

**Centerstrap II T**

Made of nylon with adjustment loops, without snap hooks.

No. 407101

**Single Net Rods Special**

For tennis net system Court Royal.

Aluminum, frame holder with rubber coating on the underside for a secure stand.

No. 404902 white

No. 404905 black



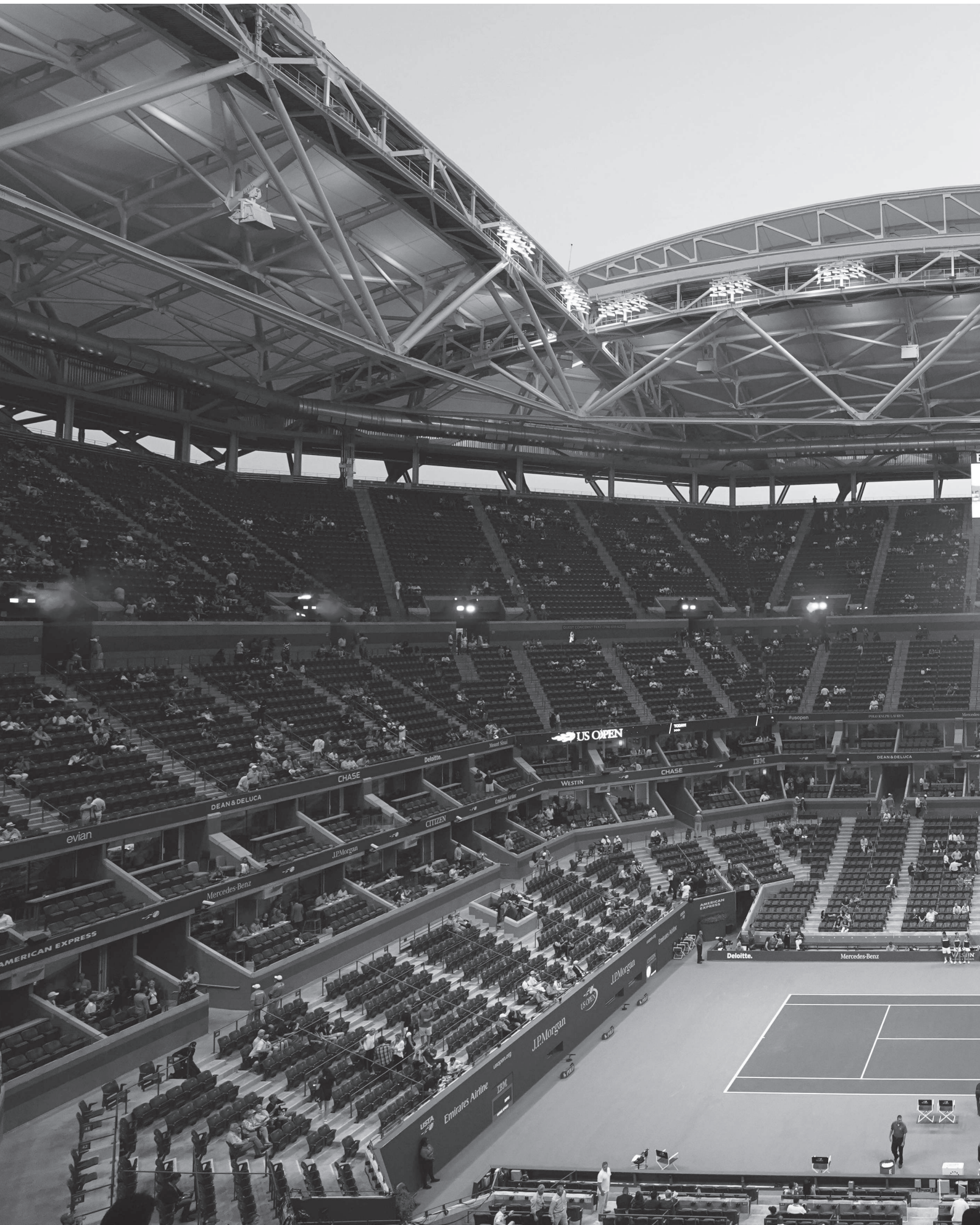

# Court Accessories

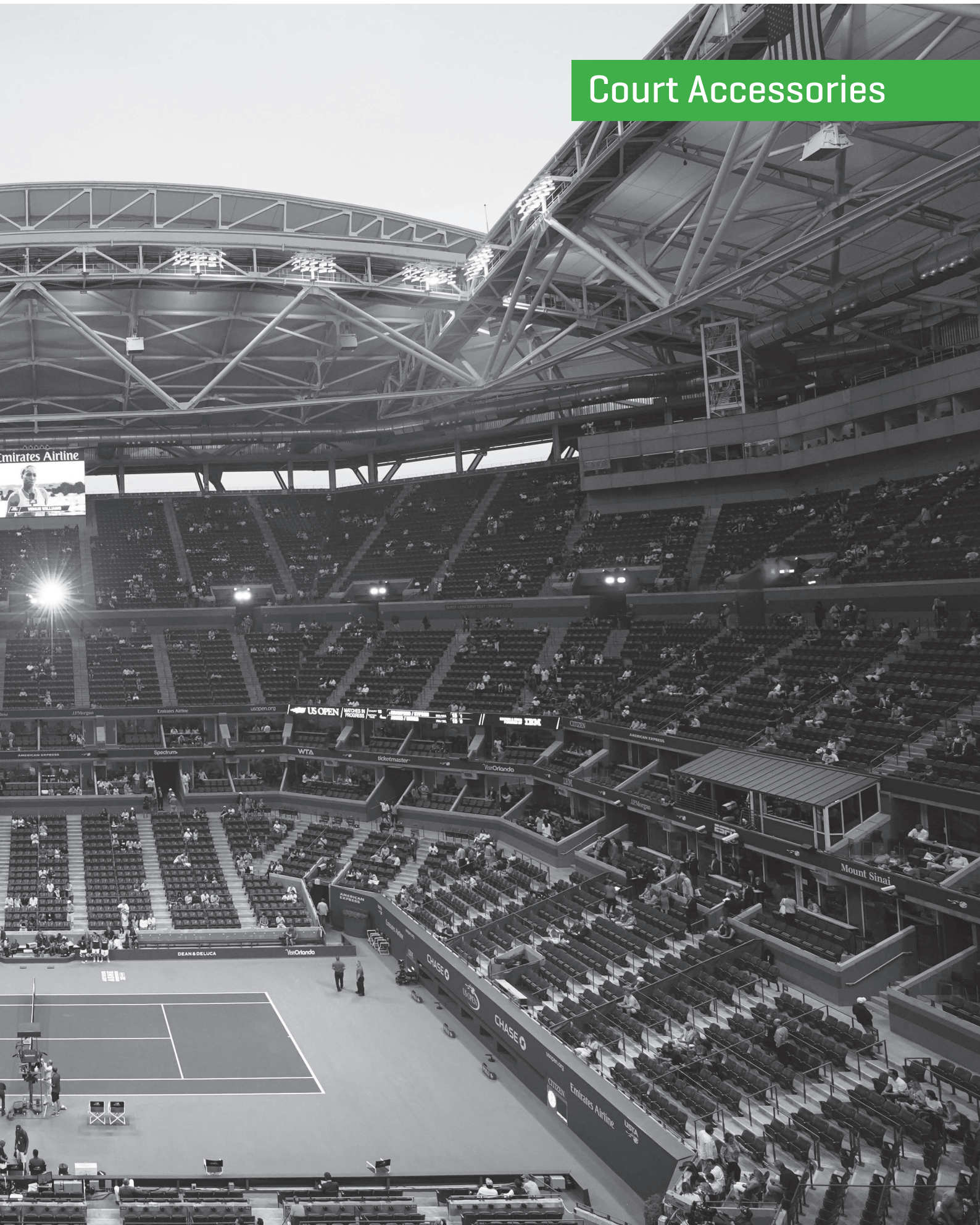

# Court Accessories

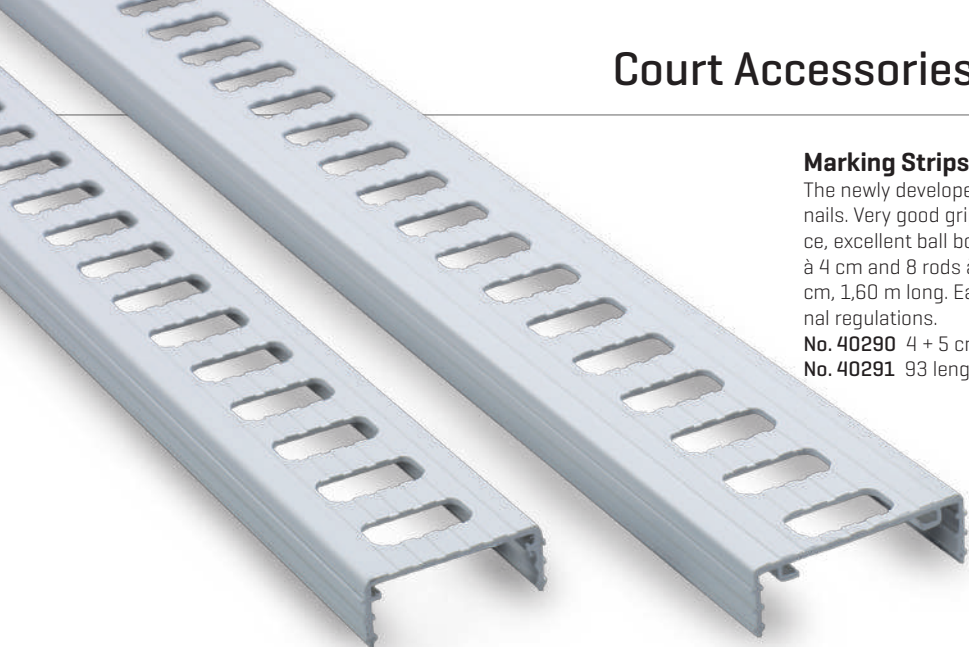

## Marking Strips with Perforations, Universal

The newly developed line with recess is ideal for simple self-installation without nails. Very good grip due to reinforce and extended barbed legs. Non-slip surface, excellent ball bounce behavior. A set of 4 cm and 5 cm consists of 85 rods à 4 cm and 8 rods à 5 cm, each 1,60 m long. A 5 cm set consists of 93 rods of 5 cm, 1,60 m long. Each set contains 100 T-connectors. Complying with international regulations.

No. 40290 4 + 5 cm

No. 40291 93 lengths 5 cm

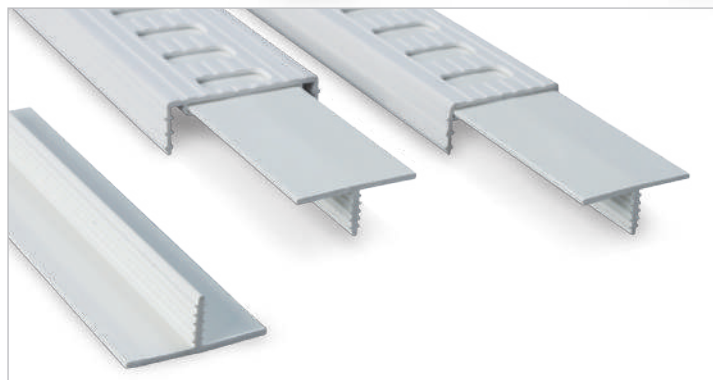

## Replacement Marking Strips with Perforations

Complete with connectors. Set of 10 lengths, each 1.60 m

No. 40292 4 cm

No. 40293 5 cm

## T-connectors

100 per set

No. 40301



## Marking Line I

Installation requires only a few nails (nails not included). Set consists of 3 rolls, each roll 50 m.

No. 40200 4 cm

Only available in complete sets.

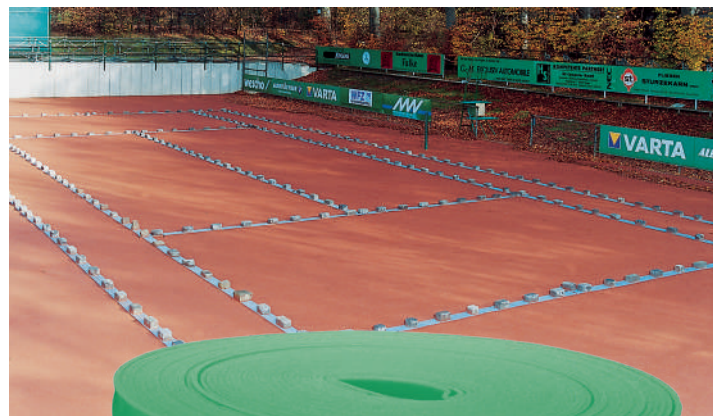

## Fastening Nails

Rounded, flat-head, hot-dip galvanized.

Specially made for tennis lines.

5 kg required for each court.

No. 40310



## Treated Wooden Pegs

For securing the corner points. 16 pegs required for each tennis court.

No. 40330



## Iso-Line

Anti-frost line covering. Protection against frost and other extreme weather conditions. Polyethylene 150 mm wide, 8 mm thick, set consists of three rolls, each 50 m. The tape should be weighted down with stones every 30 cm.

No. 40341



# Court Accessories

## Tennis Line Speziala / Court Plus

This tennis line has been developed especially for clay courts. Made of flexible, hard PVC. With 4 mm wide lateral slits, at 28 mm intervals. The lines for double courts are supplied in 6 rolls. Hard PVC and lateral slits allow the lines and court surface to interlock perfectly. The lines are anchored with 18 ground plugs per court, which are included with all line sets. The installation of the lines can be carried out by only 1 person. Please choose the lines with the appropriate anchoring set for your needs.

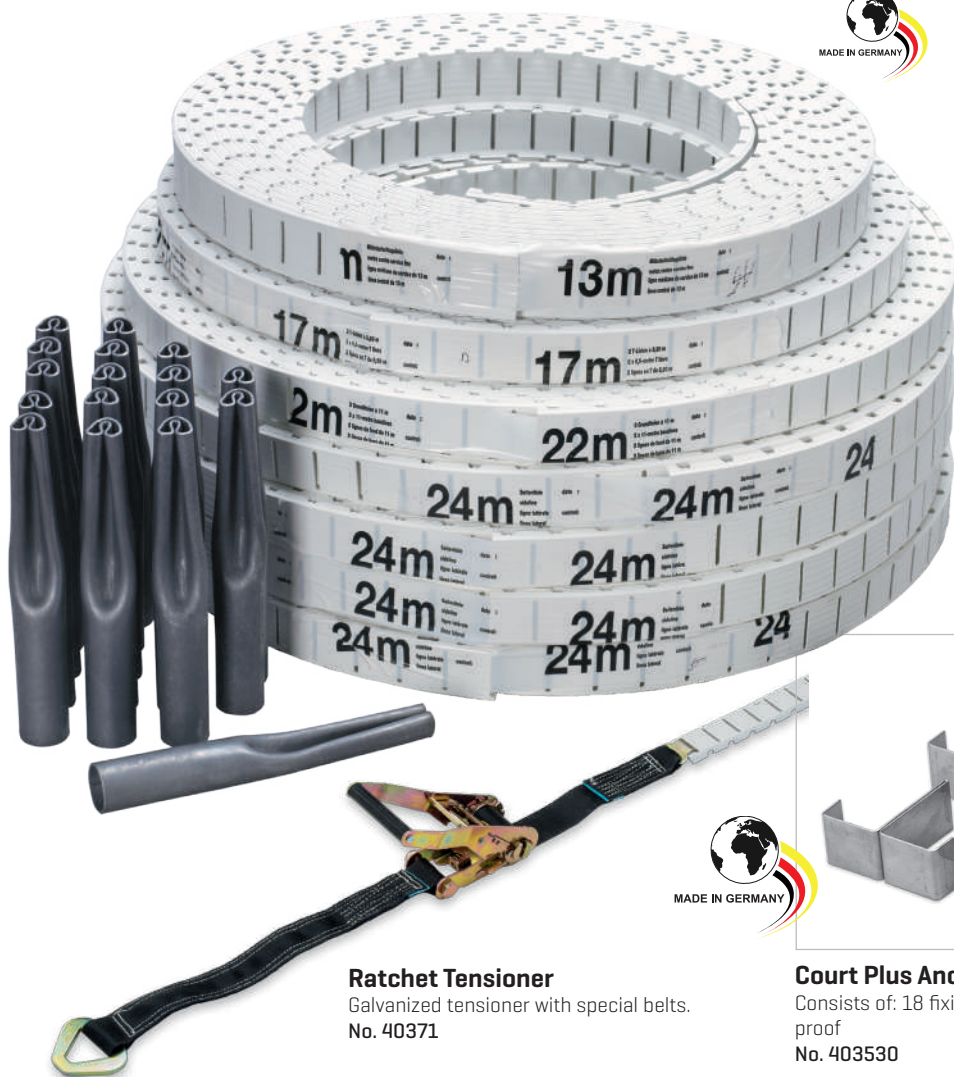

### Ratchet Tensioner

Galvanized tensioner with special belts.  
No. 40371



### Court Plus Anchoring Set

Consists of: 18 fixing clamps, rust-proof  
No. 403530

### Fixing Clamps

Made from stainless steel. For better anchorage of the corners. Fits to all Speziala sets.  
No. 40353

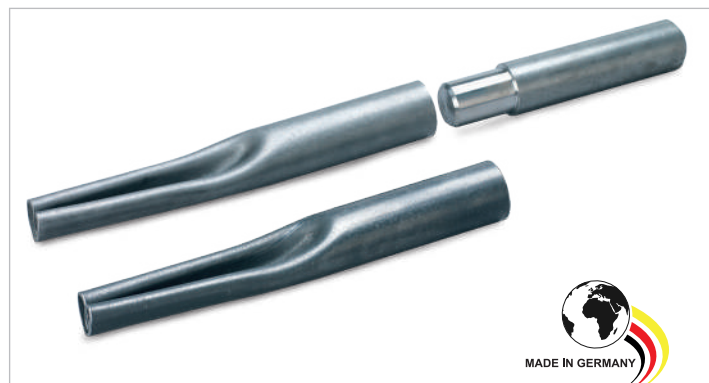

### Drive-in Peg for Anchor Tube

Made of steel. In order to avoid damages while bashing the ground anchors, it is highly recommendable to use the drive-in-peg for anchor tubes.  
No. 40376

### Anchor Tube Ground Plug

No. 40373

### Anchor Tube Floor Dowel

made from stainless steel  
No. 403730

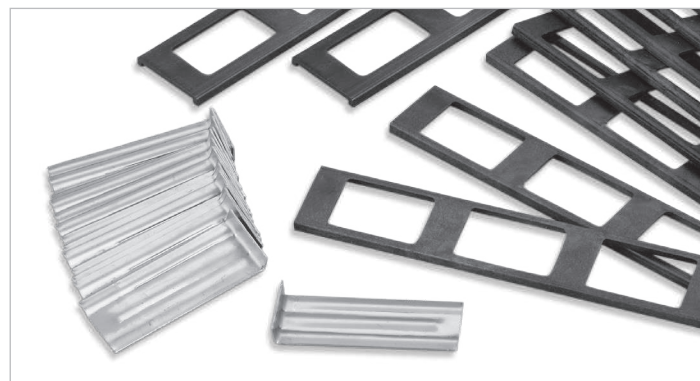

### Speziala Anchoring Set I

Consists of: 18 stainless steel tubular anchors, 16 pieces with 4 cm anchors and 2 pieces with 5 cm anchors.  
No. 403760

### Speziala Anchoring Set II

Consists of: 18 stainless steel tubular anchors, 8 pieces with 4 cm anchors and 10 pieces with 5 cm anchors.  
No. 403761

### Speziala Anchoring Set III

Consists of: 18 stainless steel tubular anchors, 18 pieces with 5 cm anchors.  
No. 403762

### Tubular Anchor

No. 40372

### End Fastener

No. 40358 4 cm

# Court Accessories



## Line Stamper

Made of plastic-coated steel. Heavy duty design to stamp in the marking lines, weight 5 kg.  
No. 40380



## Line Stamper 2

Made of steel, plastic-coated with flexible shock absorber to stamp in the marking lines. Weight 5 kg.  
No. 40381

## Marking Trolley for Tennis

New product developed for children's tennis, spreading width approx. 50 mm.  
No. 45005

## Chalk for Tennis Courts

5 kg in pail  
No. 45009



## Line Roller

This roller is ideally suited for rolling in tennis court lines. The heavy weight of approx. 65 kg and the roller width of 10 cm ensures that the line is pressed in quickly and neatly. No stamping required.  
No. 40384

## Chalk Spray

Mipa chalk spray is ideal for touching up markings on the tennis court. The spray is a special paint that dries quickly and is environmentally friendly. It can also be easily used as a temporary marker in parking lots or other areas. The marking wears off automatically depending on weather conditions and use. In this set you get 2 bottles with 750 ml. To mark a tennis court completely, you need 2 bottles.  
No. 40522



# Court Accessories



## No Sand Shoes Sign

Size 300 x 300 mm.  
white plastic board.  
No. 41283



## Tennis Court Reservation Clock

Each player can set the clock by hand for the period he wants to book the court. Size: 40 x 40 cm  
No. 41910



## Sign for Court Rules

White plastic board with sweeping illustration.  
No tennis court should be without this sign.  
Size 500 x 330 mm.  
No. 41241 German  
No. 412401 English  
No. 412402 French



## Court Closed Sign

Size 300 x 200 mm, white plastic board.  
No. 412431



## Match Timer

The new tennis court booking clock with integrated court number, made of weatherproof plastic. Can be set to 1 hour for singles or 1 1/2 hours for doubles.  
Size 24 x 32 cm. No. 1-12 available.  
No. 41249

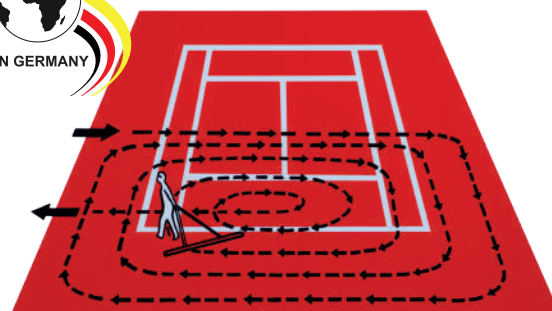

## Sweeping Illustration Sign

Size 330 x 500 mm, white plastic board.  
No. 41242



## All Courts Closed Sign

Size 300 x 200 mm, white plastic board.  
No. 412461

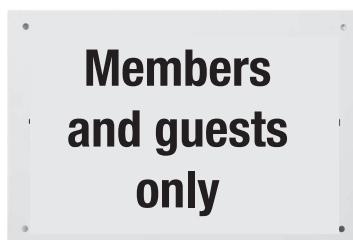

## Members and guests sign

Size 300 x 200 mm, white plastic board.  
No. 412471



## Tennis Court Numbers

White plastic board with black numbers from 0 - 9,  
size 300 x 200 mm.  
No. 41250

# Court Accessories

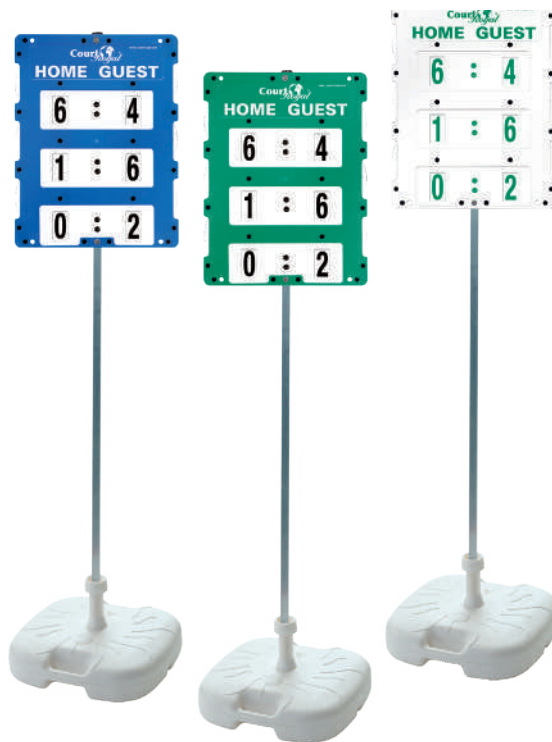

## Court Royal Pointer Heavy II

The new generation of the Court Royal Pointer II is a further development in quality and functionality to an attractive price. The fully-moulded and deep-drawn 4 mm ABS plastic plates are very robust, weather-resistant and non-fade. 6 stable easily rotatable, non-adherent turnables with 7 cm high, clearly legible numbers are hallmarks of this top product. The Court Royal Pointer can be displayed on both sides and due to its improved design with Home and Guest, it has a better clarity. Easy attachment to the fence by included special fixing.

Size: 46 x 60 cm with 7 cm high numbers.

- No. 40832 blue
- No. 40838 green
- No. 40839 white

## Court Royal Pointer Heavy II, freestanding

The new generation of the Court Royal Pointer II is a further development in quality and functionality to an attractive price. The fully-moulded and deep-drawn 4 mm ABS plastic plates are very robust, weather-resistant and non-fade. 6 stable easily rotatable, non-adherent turnables with 7 cm high, clearly legible numbers are hallmarks of this top product. The Court Royal Pointer can be displayed on both sides and due to its improved design with Home and Guest, it has a better clarity. Stable, fillable with sand plastic base with aluminum rods for fixing the Court Royal Pointers.

Size: 46 x 60 cm with 7 cm high numbers.

- No. 408321 blue
- No. 408381 green
- No. 408391 white

# Court Accessories



## Match Pointer Scoreboard

With 6 adjustable disks for 3 set scores. Display on front and back. Clearly laid out, easy-to-read design. Sturdy, weather-resistant construction from light-resistant plastic and rust-proof hardware. Easy mounting on fence or net, complete with fence mount. International version: Local/Visit

## Model Super Big international

Size: 65 x 96 cm  
with 12 cm high numbers  
No. 408151

## Model Super international

Size: 56 x 80 cm  
with 10 cm high numbers  
No. 408141

## Model Big International

Size: 46 x 65 cm  
with 8 cm high numbers  
No. 408161

## Model Little International

Size: 35 x 50 cm  
with 6 cm high numbers  
No. 408171

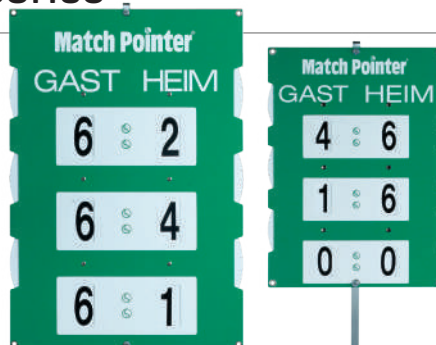

## Match Pointer Scoreboard Free-Standing

With 6 adjustable disks for 3 set scores. Display on front and back. Sturdy aluminum stand with support bar and fillable plastic foot.

### Model Big green

Size: 46 x 65 cm, with 8 cm high numbers  
No. 40818

### Model Super Big green

Size: 65 x 96 cm, with 12 cm high numbers  
No. 40819



## Spare number disks

One set contains 6 disks  
No. 40811 Model Little 6 cm numbers  
No. 408110 Model Big 8 cm numbers  
No. 408115 Model Super 10 cm numbers  
No. 408111 Model Super Big 12 cm numbers



## Scoreboard Umpire Chair

To mount on all umpire chairs. Display on front and back. The umpire flips over a card after each game. Complete with mounting hardware.

No. 408305



## Scoreboard

This practical scoreboard is simply placed over the net. The numbers are flipped over to show the score from both sides. From 0 - 9, size 11 cm, incl. bag.

Size: 15 x 18 cm

No. 40835

# Court Accessories



## Umpire Chair Court Royal Deluxe

This aluminum umpire chair with European Seal of Approval DIN EN 131, meets the highest standards. The ladder with its especially wide slip-proof rungs, as well as the projecting supports with four base plates, gives this chair optimum stability.

The middle plate between the ladder and the supports provides extra durability. The seat mount has an extra crossbar behind the red, UV-resistant body-contoured seat.

Seat height 1885 mm, correspond to ITF, ATP und WTA Standard.  
No. 40809

## Umpire Chair Court Royal Tournament

Elegant aluminum umpire chair with European Seal of Approval DIN EN 131. Very robust because of the stable ladder and the projecting supports with four base plates. The seat mount has an extra crossbar behind the red, UV-resistant body-contoured seat. Seat height 1885 mm, correspond to ITF, ATP und WTA Standard.

No. 40800



## Umpire Chair Court Royal Deluxe powder-coated

Same features as model No. 40809, green, white or blue powder-coated, with green, white or blue seat.

No. 408098 white

No. 408099 green

No. 408088 black

# Court Accessories



## Advertising Umpire Chair Court Royal Deluxe Grand Slam

This heavy duty chair is ideal for advertising with 2 side panels of 10 mm PVC and 3 mm panels between steps. Plastic-coated aluminum base with UV-resistant seat and PVC table. Supplied without advertising. Supplied in standard color white, also available in green or other RAL colors on request.

No. 408101 white

### 4-color digital printing

Please provide file for printing.

No. 407934

## Advertising Umpire Chair Court Royal Deluxe Grand Prix

Plastic coated aluminum chair with UV-resistant seat and PVC table, ideal for advertising. Base frame with two side panels of 10 mm PVC. Supplied without advertising. Supplied in standard color white, also available in green or other RAL colors on request.

No. 408100 white

### 4-color digital printing

Please provide file for printing.

No. 407941



## Ambrella for Umpire Chairs

Very solid, tiltable parasol, 150 cm diameter with a quick release device, including fittings.

No. 408005 red

No. 408011 green

No. 408012 blue



## Seat Court Royal

No. 408148 green

No. 408150 red

No. 408149 white

No. 408147 blue

## Seat red

No. 40771

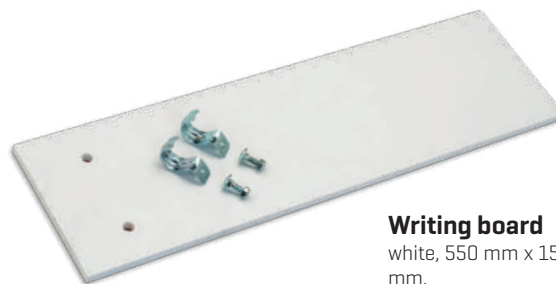

## Writing board

white, 550 mm x 15 mm x 10 mm.

Nr. 408097

# Court Accessories



## Players' Bench Grand Slam Aluminum 150 cm long

The bench is an ideal advertising medium and is used worldwide at international tennis tournaments and in football stadiums. High-quality aluminum construction, white powder-coated. The seating surface consists of 5 multi-chamber profile slats, supplied in four parts, easy assembly. The 10 mm PVC advertising panels are preassembled without an advertising logo. Weight 27 kg. No. 41222 white

### 4-color digital printing

Please provide file for printing.  
No. 412221



## Advertising Bench Freiburg GFK 150 cm

2 all-plastic legs and 5 multi-chamber plastic slats serving as a seat and a KU backrest for easy attachment of advertising stickers. This exclusive, high-quality GFK model is very robust and specially developed for extremely hot regions. No. 41208 white

### 4-color digital printing

Please provide file for printing.  
No. 412209



## Umbrella holder for plastic benches

From now on you are sitting in the shade. The new umbrella holder, made of aluminum, can be screwed onto the existing screws of the benches Köln, Freiburg and Berlin. Suitable for umbrellas with a diameter of 25 mm. No. 4080097



## Umbrella Holder for Players' Bench

Made of white, powder-coated aluminum, with fittings for easy mounting. No. 408007



## Umbrella Nuovo

Very solid, tiltable parasol, 150 cm diameter with a quick release device. 8 pieces, made of 100% polyester fabric, approx. 160g/qm, weatherproof. Fits the umbrella holder for plastic benches as well as the Robusto umbrella stand.  
No. 408009 red  
No. 4080091 green  
No. 4080092 blue

## Umbrella Stand Sun

Very stable umbrella stand made of plastic, with rotatable support that can be adapted to different diameters. The stand can be filled with water or sand. Dimensions: 45 x 46 cm  
No. 408182



## Court Accessories



### Deluxe Tennis Bench

Our newly designed tennis court bench has everything you could wish for.

Plenty of space (approximately 100 x 45 cm) in the middle for bags and rackets, two comfortable seats, with plastic-, weather- and light-resistant seat pads, 57 cm wide and 50 cm deep. Super robust design. A first class product.

No. 41213 white

### Bench Hohenzollern

Elegant, yet extremely robust bench for tennis courts and outdoor use. With armrests, seat width 150 cm, seat depth 50 cm. Solid plastic construction with integrated, stainless steel brackets. Seat and back are supplied preassembled to make setting up easier.

No. 412012 white



**Bench Cologne** 120 cm long, white  
2 plastic legs and 9 multi-chamber plastic slats, foldable. Proven high-quality.  
Weight approx. 13 kg.  
No. 412233 white



**Bench Cologne** 120 cm long, green  
2 plastic legs and 9 multi-chamber plastic slats, foldable. Proven high-quality.  
Weight approx. 13 kg.  
No. 412234 green

# Court Accessories



**Bench Munich** 150 cm long, white  
2 plastic legs and 5 multi-chamber plastic slats, without backrest and therefore usable from both sides. Practical and comfortable to sit on. Weight approx. 9 kg.  
No. 412210 white



**Bench Munich** 150 cm long, green  
2 plastic legs and 5 multi-chamber plastic slats, without backrest and therefore usable from both sides. Practical and comfortable to sit on. Weight approx. 9 kg.  
No. 412211 green



**Bench Freiburg** 150 cm long, green  
2 plastic legs and 9 multi-chamber plastic slats with reinforcement bracket in the center, foldable. Proven high-quality. Weight 15,5 kg.  
No. 41200 white  
No. 41199 green



**Bench Helgoland** 150 cm long, green  
2 plastic legs and 12 multi-chamber plastic slats with reinforcement bracket in the center, foldable. Practical and comfortable to sit on. Weight approx. 21 kg.  
No. 41203 white  
No. 41207 green

# Court Accessories



**Bench Stuttgart** 200 cm long, green  
3 plastic legs and 5 multi-chamber plastic slats, without backrest therefore usable from both sides. Practical and comfortable to sit on. Weight approx. 11,5 kg.  
No. 412212 white  
No. 412213 green



**Bench Berlin** 200 cm long, green  
3 plastic legs and 9 multi-chamber plastic slats, foldable. Proven high-quality. Weight 18,5 kg.  
No. 41210 white  
No. 41211 green



**Bench Sindelfingen** 200 cm long, white  
3 plastic legs and 12 multi-chamber plastic slats. Practical and comfortable to sit on. Weight approx. 26 kg.  
No. 41204 white  
No. 41212 green

# Court Accessories

## Brush Shoe Cleaner Ideal

Made of zinc-coated steel with high-quality bristles. Ideal cleaner for sand and clay courts. 600 x 400 mm.

No. 41284

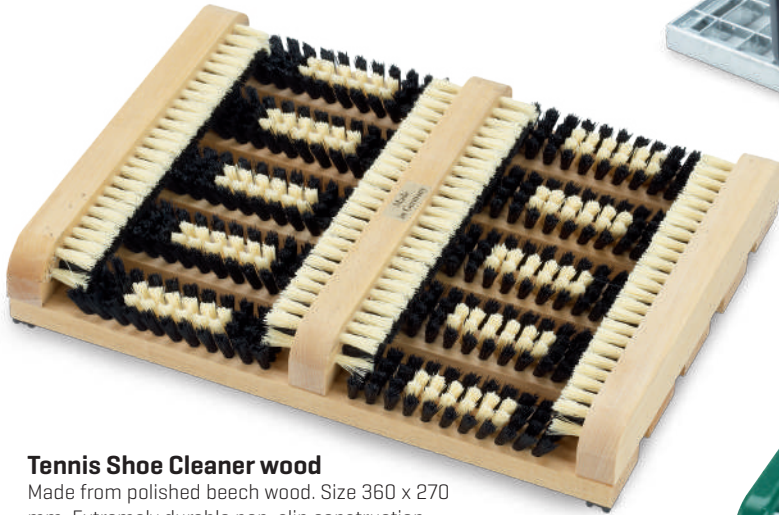
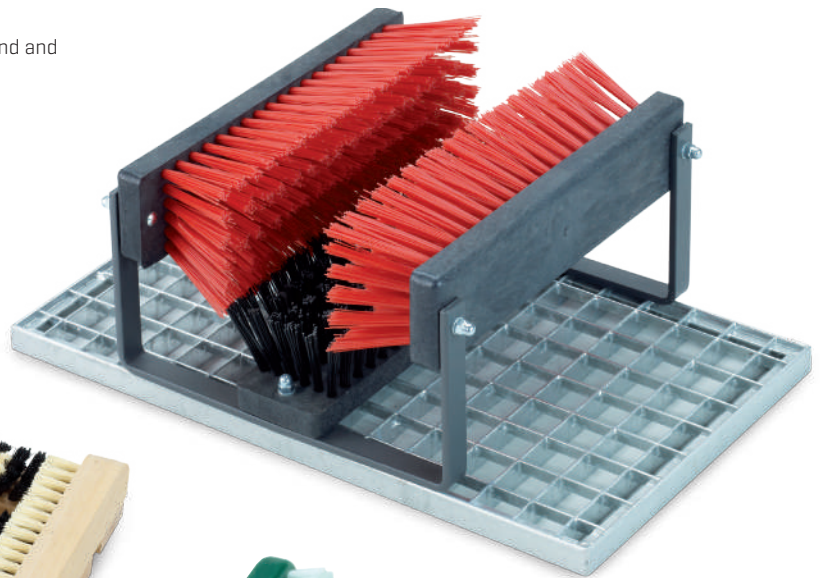

## Tennis Shoe Cleaner wood

Made from polished beech wood. Size 360 x 270 mm. Extremely durable non-slip construction.

No. 41269



## Tennis Shoe Cleaner Little

Solid plastic construction. Size 270 x 350 mm

No. 41271

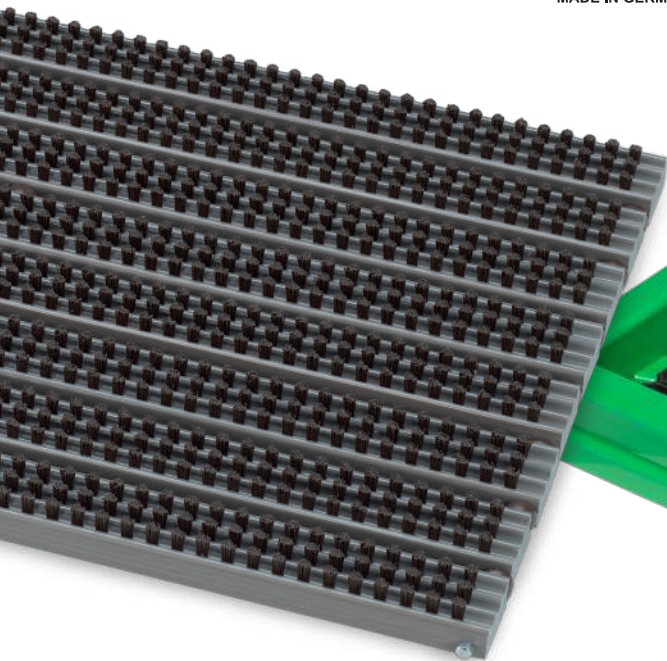

## Shoe Cleaning Mat Atlantis

A solid, stiff brush mat made of recyclable synthetic material. Width: 590 x 380 x 30 mm.

No. 41280



## Shoe Cleaning Tub

The perfect cleaner for all kind of sports shoes. Fine sprays of water in the punched rubber mats clean the soles of the shoes when triggered by the person's weight. Can be used for clay, granule and sand courts. Dirt remains in the tub. Easy to clean.

Size 600 x 500 mm.

No. 41286

# Court Accessories



## Waste Bin 50 I

UV-resistant plastic waste bin. Heavy-duty hot galvanized metal fixture for fastening to poles, railings or walls. Complete with hardware and key.

No. 41233 green

No. 41234 orange



## Designer Waste Bin „Tennis Ball“

In the shape of a tennis ball, approx. 50 cm Ø. Made from top-quality special plastic. Completely UV and weather-resistant. Hinges and fastening materials made from stainless steel. Hinged lid. Standard version with 2 quick-release straps for mounting on poles, railings or walls.

No. 41224 yellow

No. 41223 green

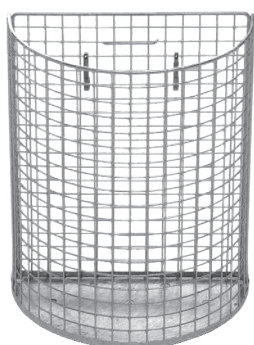

## Wire Waste Bin 18 I

Semi-circular, galvanized with perforated metal base to drain water. Spring hooks for fastening to fence. Size: height 14 cm, width 32 cm, depth 17 cm.

No. 41236

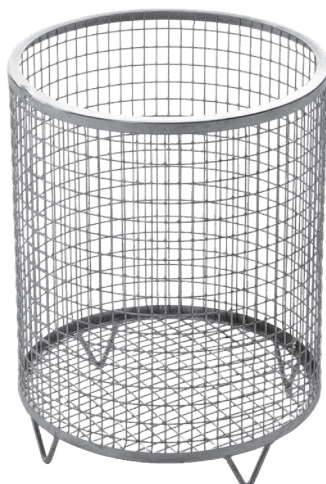

## Wire Waste Bin 63 I

2 mm sturdy, strong hot-galvanized frame. 4.8 mm round steel legs. Size: 40 cm Ø; height 50 cm.

No. 41277

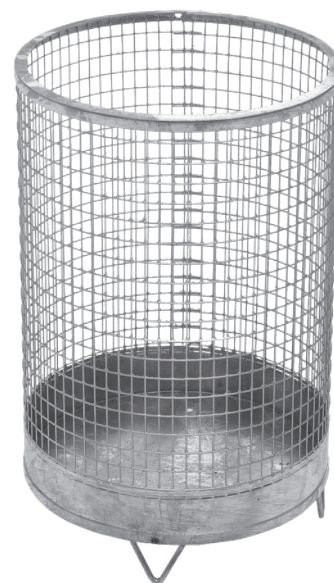

## Wire Waste Bin 75 I

2 mm strong hot-galvanized frame with 4.8 mm round steel legs. Metal base with holes for water drainage. Size: 40 cm Ø; height 60cm

No. 41278

# Court Accessories

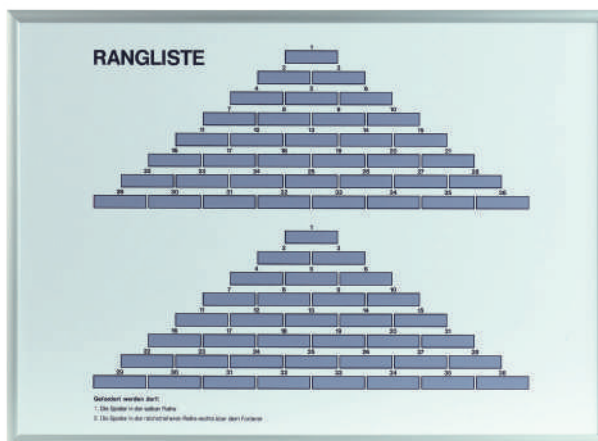

## Pyramid Ranking List I

Sturdy metal panel, galvanized and clamped in an aluminum frame, printed on weatherproof PVC film.

Size: 68 x 50 x 2,5 cm.

No. 41970

## Ranking List I

Sturdy metal panel, galvanized and clamped in an aluminum frame, printed for women, men, senior men, senior women, junior boys and junior girls. For use with magnetic markers. Size: 50 x 68 x 2,5 cm. Please indicate required text with your order.

No. 41950

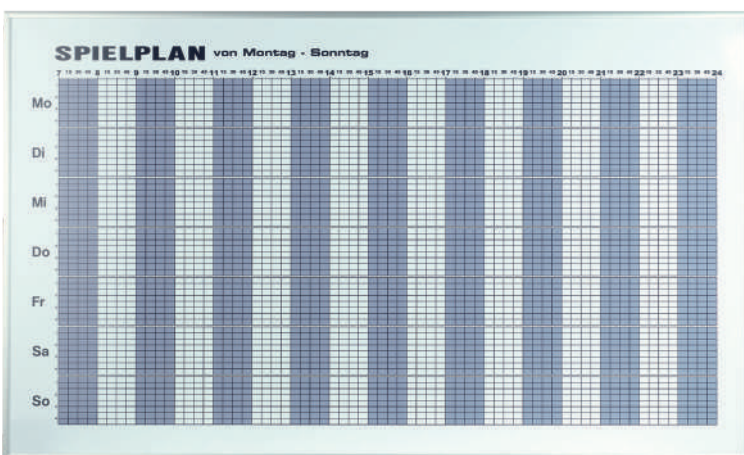
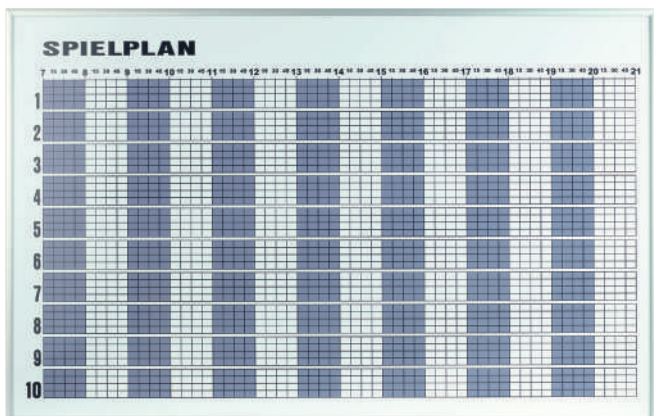

## Weekly Reservation Plan

As above, though for clear weekly reservations. Arranged from Monday to Sunday, game times from 7 a.m. to midnight.

No. 41710 Plan for 2 courts 150 x 89 cm

No. 41720 Plan for 4 courts 150 x 89 cm

No. 41730 Plan for 8 courts 150 x 89 cm

## Daily Information Plan

Bring order and clarity into the game by hanging magnetic nameplates in the corresponding sections. The chips can be marked in different colors for women, men, juniors, etc. The game times for team training, maintenance, trainer court, etc. can be clearly and easily reserved. The division into hours means that players can book between 45 and 115 minutes on court, more for doubles, by tagging the chips. The color-coded hourly division enables fast and easy time planning, especially for the lower courts. The sturdy metal panel is galvanized and clamped in an aluminum frame. The plan is printed brown on a white, photostable and weatherproof washable PVC film. Game times from 7 a.m. to 9:30 p.m.

No. 41670

Plan for 4 courts, 120 x 38 cm

No. 41680

Plan for 6 courts, 120 x 50 cm

No. 41690

Plan for 8 courts, 120 x 68 cm

No. 41700

Plan for 10 courts, 120 x 75 cm

## Storage Board

50 x 68 x 4 cm

No. 41738

## Magnetic Signs

60 x 10 mm

No. 41740

## Magnetic Signs

80 x 10 mm

No. 41750

## Embossing Tapes Dymo

9 mm wide, 3 m long, choice of color

No. 41760

## Embosser Dymo 1755

New, robust version

No. 41770



# Court Accessories



Showcase 41940 with lettering strip including lettering



## Showcase TMD 95

Suitable for outside and inside use, absolutely weatherproof design. Made of top grade, torsion-free aluminum sections, depth 95 mm. The surface is anodized in matt silver (E6-EV1). State-of-the-art manufacturing processes and advanced processing machines have been combined with technical know-how to provide a solid basis for this quality product.

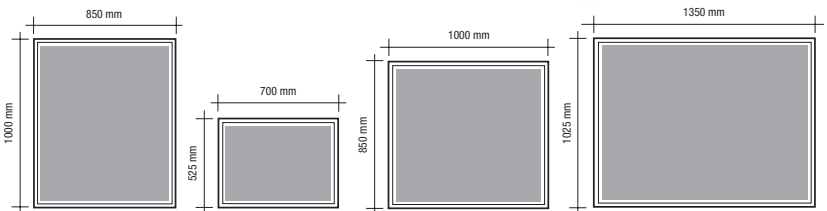

### Basic frame

Very robust aluminum base frame with inset steel back wall with corrosion-resistant coating.

### Front frame

Aluminium front frame made of torsion-free multi-chamber aluminum sections with integrated weatherproof rubber seal and shatter-proof acrylic glass pane.

### Front frame fitting

Special interlocking sections across the whole width so that no hinges are required; this provides greater stability.

### Front frame opening

The front frame opens upwards and is held open by rods which engage automatically. The catch is released by lifting the front frame up again.

### Safety lock

Safety lock located on the bottom edge with two keys. Simple and troublefree operation.

### Wall fastening

The information board is fastened to the wall by means of two aluminum section rails; the board is then inserted into the rails and fixed by two screws at the bottom. All fastening elements are accommodated in the frame sections. It is not possible to dismount the information board when it is closed. This protects it very effectively from theft.



Showcase TMD 95					
Measuring: width x height x depth 95 mm	mm	700 x 525	1000 x 850	850 x 1000	1350 x 1025
Inner dimension: width x height x depth 80 mm	mm	640 x 465	940 x 790	790 x 940	1290 x 960
incl. Magnets (Ø 30 mm)	piece	10	20	20	20
Weight	kg	12	20	20	33
For outdoor and indoor use. Anodized (E 6-EV 1) aluminum housing with black magnetic board, safety lock with two keys and wall fixing set.	Art.-No.	41920	41930	41933	41940
<b>Accessories</b>					
<b>Lettering strip, neutral</b> Acryl glas 4 mm, translucent white H 120 mm	Art.-No.	47100	47101	47102	47103
<b>Lettering strip, with lettering</b> Version as above, but with choice of text (print letters)	Art.-No.	47110	47111	47112	47113
<b>Pair of stands to set in concrete</b> For free-standing installation. 2 aluminum square tubes 50 x 50 mm, height 2400 mm	Art.-No.	41947	41947	41947	41947
<b>Magnets</b> Ø 30 mm, 10 per set	Art.-No.			41929	

# Court Accessories



## The high-quality screen, proven and tested thousands of times worldwide

Heavy-duty polyethylene fabric, UV-stabilized, lets wind through. Full border with plastic-lined brass eyes every 50 cm, thus very resistant to tearing.

**Wind Screen Super** The Quality Super weighs 160 g/qm is wind permeable and is available in the colours light- and dark green. It is the most sold wind screen. Only available in 12 x 2 m.

**Wind Screen Exclusive** The quality of Wind Screen Exclusive weighs 140 g/qm and is extremely wind permeable and is excellently suited for printing, available in the colours light and dark green, yellow, white, blue, red and black. Standard size 12 x 2 m, but also available in length of 50 m and height of 4 m.

**Printing** Our panels are printed with special, UV-resistant inks, therefore particularly good adhesion and long durability. In the standard, the panels are printed in black. Other printing inks plus 25% surcharge. All company logos, logos and lettering can be created on request. Photo prints are also possible. The prerequisite for production is the delivery of a printable file (vectorized or print PDF) by the client. Production only after approval of the control template [PDF].



### Fastening - S - Hook

Thickness 4 mm, length 56 mm, width 18 mm  
No. 41520

### Spring Hooks

Galvanized, 60 hooks needed  
per 2 x 12 screen  
No. 41530



## Windscreen Digimesh

Photo digital printing in 4C from photo-realistic templates. With silver-colored ring eyelets every 50 cm. Dimensions: 12 m x 2 m  
No. 415176



Technical changes reserved. Pictures are partially illustrations.



# Court Accessories



## Wind Screen Light Green Super

With metal eyelets every 50 cm

- No. 415115 dimensions: 12 m x 2 m
- No. 415103 dimensions: 17 m x 2 m
- No. 415119 dimensions: 16 m x 3 m
- No. 415104 dimensions: 18 m x 3 m



## Wind Screen Dark Green Super

With metal eyelets every 50 cm.

- No. 415105 dimensions: 12 m x 2 m
- No. 415109 dimensions: 17 m x 2 m
- No. 415110 dimensions: 16 m x 3 m
- No. 415113 dimensions: 18 m x 3 m



## Sichtblende Exklusiv Color

With metal eyelets every 50 cm. Dimensions: 12 m x 2 m.

- No. 41510 dark green
- No. 41511 light green
- No. 41512 blue
- No. 41513 white
- No. 41514 black
- No. 41515 yellow
- No. 41516 red



## Windscreen Exclusive with Advertising Printing

With metal eyelets every 50 cm. Color: light green or dark green  
Dimensions: 12 m x 2 m.

- No. 415171 printing up to 40%



## Windscreen Exclusive with Advertising Printing

With metal eyelets every 50 cm. Color: light green or dark green  
Dimensions: 12 m x 2 m.

- No. 415172 printing up to 60%



## Windscreen Exclusive with Advertising Printing

With metal eyelets every 50 cm. Color: light green or dark green  
Dimensions: 12 m x 2 m.

- No. 415173 printing up to 80%

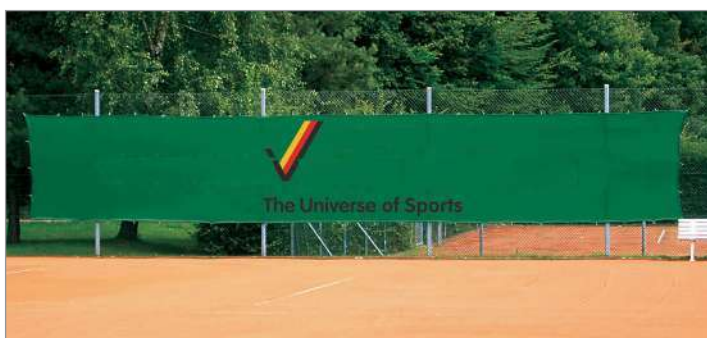

## Windscreen Advertising Superprinted

With metal eyelets every 50 cm. Dimensions: 12 m x 2 m.

- No. 41500 dark green
- No. 41501 light green



## Windscreen Advertising Super printed

With metal eyelets every 50 cm. Dimensions: 12 m x 2 m.

- No. 41503 dark green
- No. 41504 light green

# Court Accessories



## Standard Dividing Net

Robust polyethylene net 2.4 mm thick, mesh width 4.5 mm. For tennis hall and outdoor use. Complete with steel wire, approx. 4 mm thick, 38 m long, 1 tension lock, lead cord weighs 200 g/m and nylon guide rings, 3 rings to be fitted to the net per meter.

Size 40 x 2,5 m

- No. 41570 white
- No. 41571 green
- No. 41572 black

Size 40 x 3 m

- No. 41580 white
- No. 41581 green
- No. 41582 black

## Support Rod

Made of aluminum, with large support base, free-standing. Freely adjustable by telescopic mechanism from 2 m to 3 m. 3 support rods are needed to support the standard dividing nets.

No. 41585



## Dividing and Stop Nets 2,3 mm

Made of high-strength polypropylene, mesh width 45 mm.

No. 41590 white



## Dividing and Stop Nets 2,3 mm

Made of high-strength polypropylene, mesh width 45 mm.

- No. 41600 green
- No. 41591 black

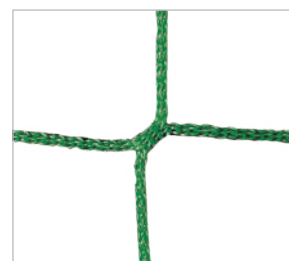

## Dividing and Stop Nets 3 mm

Made of high-strength polypropylene, mesh width 45 mm.

No. 41610 green

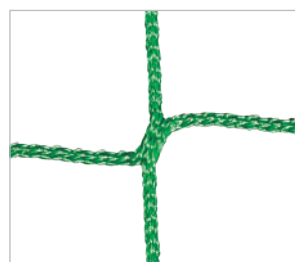

## Dividing and Stop Nets 4 mm

Made of high-strength polypropylene, mesh width 45 mm.

No. 41611 green

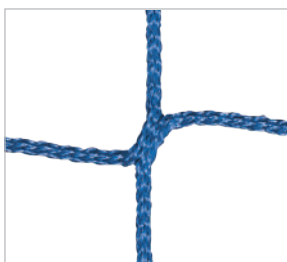

## Dividing and Stop Nets 4 mm

Made of high-strength polypropylene, mesh width 45 mm.

No. 41613 blue

## Lead Cord

Directly sewn to the net as weighting

- No. 41620 200g
- No. 41621 400g

## Plastic Guide Rings

Made of nylon, black, 3 integrated in the net for each meter

No. 41630

## Wire

Made of zinc-plated steel

- No. 41640 4 mm
- No. 41641 6 mm

## Tensioning Set

Eye rings and tension lock each end

- No. 41650 for 4 mm
- No. 41651 for 6 mm

Additional charge for small orders per single net:

- nets of less than 5 sqm + 100%
- nets of less than 20 sqm + 20%
- nets of less than 10 sqm + 35%

# Court Accessories



## Standard Dividing Net Super black

The newly developed knotted dividing net with a material thickness of 1,6 mm for indoor and outdoor use is absolutely weather-resistant and extremely tearproof. Due to the colour black and the thin material the net is more transparent than the conventional dividing nets. The mesh size is 4,5 cm. Complete with 38 m long steel wire and 2 tension locks. 200 g/m cord weighs and 3 galvanized snap hooks per meter. Size 40 m x 3 m  
No. 42500



## Rubber Granules

For scattering onto slippery surfaces in indoor tennis courts. Grain size 0.5–1.5 mm. Special granulate, non-abrasive, dust-free, anti-static, odorless, non-slip. Supplied in 25 kg sacks. Ideal for topping up.

No. 47010	Color: red
No. 47020	Color: green
No. 47030	Color: blue

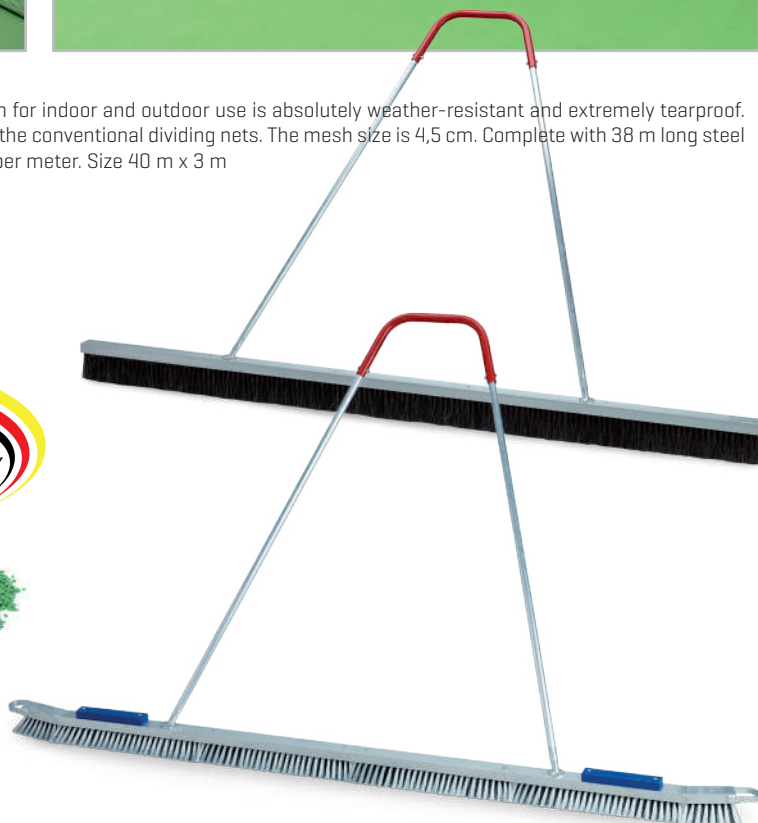

## Broom for Granular Surfaces [above]

Broom with Arenga bristles for hall floors with rubber granular. The special position of the bristles guarantees an even sliding of the broom. Complete with a very sturdy aluminum handle in three parts. Working width 200 cm.  
No. 41075

## Granu-Top Broom [below]

This is the perfect broom for cleaning granular surfaces. The bent ends of the broom and the position of the bristles guarantee an even spread of granules. The static supercharge cleans debris abraded from the balls and lint from the surface. Complete with aluminum handle and weights on both ends. Working width 200 cm.  
No. 41076

## Replacement Brush for Granu-Top

No. 410761

# Court Accessories

## Compact

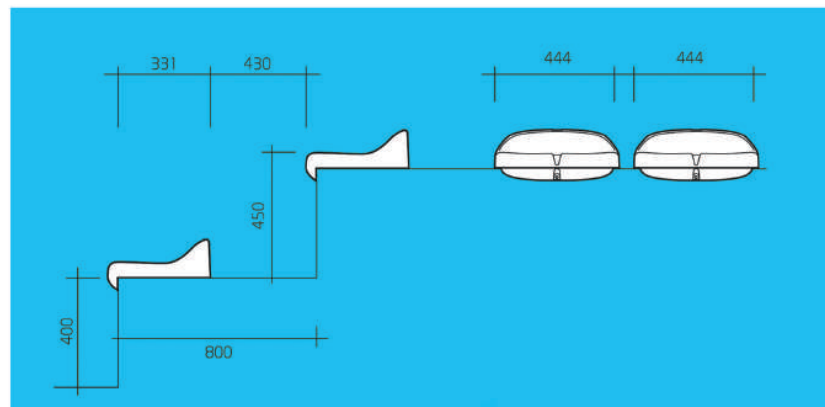
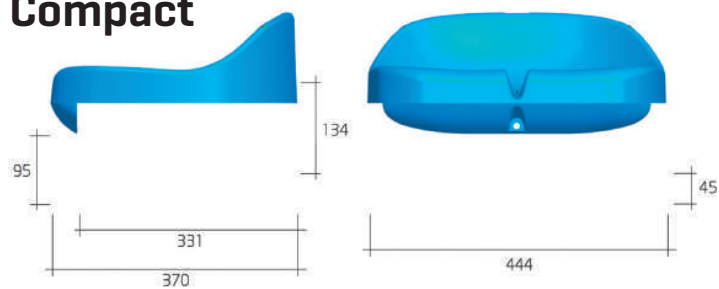

### Tribune Seat Compact for Self Assembly

Made of moulded, shock-resistant, UV-resistant polypropylene. Fast and simple assembly on nearly every underground due to triple fittings. The attachment points are protected against vandalism. All seat shells are equipped with a water drain. Available in the colours: black, white, orange, green, blue, yellow, red, grey. Please indicate the colour. For an additional charge, the seats can be numbered (flame-retarding on request).

Weight: 0.810 kg



No. 409628 PANTONE 3686



No. 40962 RAL 9017



No. 409621 RAL 9016



No. 409622 RAL 2008



No. 409623 RAL 60017



No. 409624 RAL 5015



No. 409625 RAL 1018



No. 409626 RAL 3000



No. 409627 RAL 7001

# Court Accessories

## Elegance

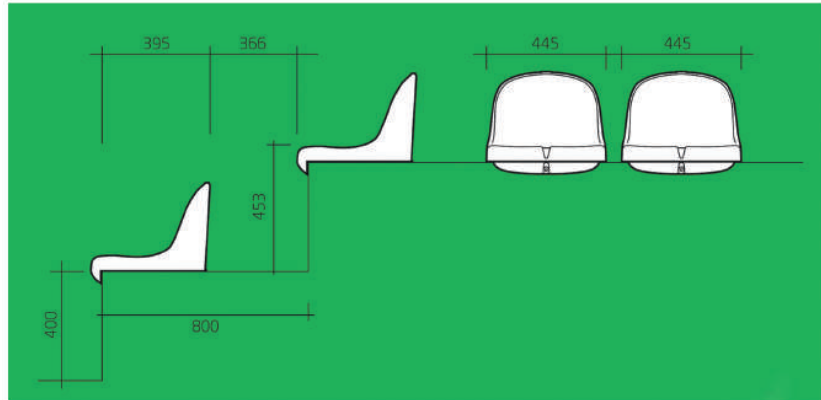
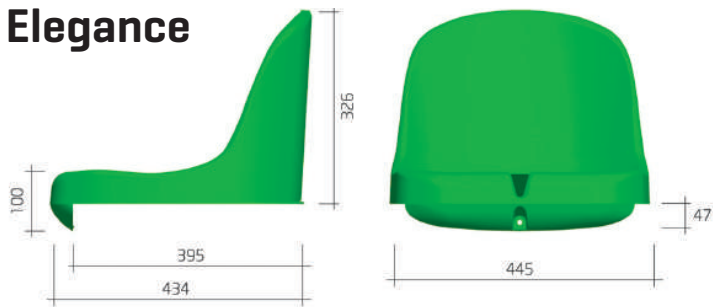

### Tribune Seats Elegance for Self Assembly

Made of moulded, shock-resistant, UV-resistant polypropylene. Fast and simple assembly on nearly every underground due to triple fittings. The attachment points are protected against vandalism. All seat shells are equipped with a water drain. Available in the colours: black, white, orange, green, blue, yellow, red, grey. Please indicate the colour. For an additional charge, the seats can be numbered (flame-retarding on request).  
Weight: 1.930 kg



No. 409638 PANTONE 3686



No. 40963 RAL 9017



No. 409631 RAL 9016



No. 409632 RAL 2008



No. 409633 RAL 60017



No. 409634 RAL 5015



No. 409635 RAL 1018



No. 409636 RAL 3000



No. 409637 RAL 7001

# Court Accessories

## Tribune Court Royal with 50 seats, three-rowed

The new Tribune Court Royal is suitable for all kind of outdoor sports. It is equipped with 50 comfortable three-rowed seats as well as a middle staircase and rails. The construction is of steel profile barrels and heavyweight grates as flooring. All steel parts are galvanized and absolutely weather-resistant. The UV-resistant plastic bucket seats offer sitting comfort and can be delivered in different colours.



## Tribune Court Royal with 50 seats, three-rowed

The new Tribune Court Royal is suitable for all kind of outdoor sports. It is equipped with 50 comfortable three-rowed seats as well as a middle staircase and rails.

The construction is of steel profile barrels and heavyweight grates as flooring. All steel parts are galvanized and absolutely weather-resistant. The UV-resistant plastic bucket seats offer sitting comfort and can be delivered in different colours.

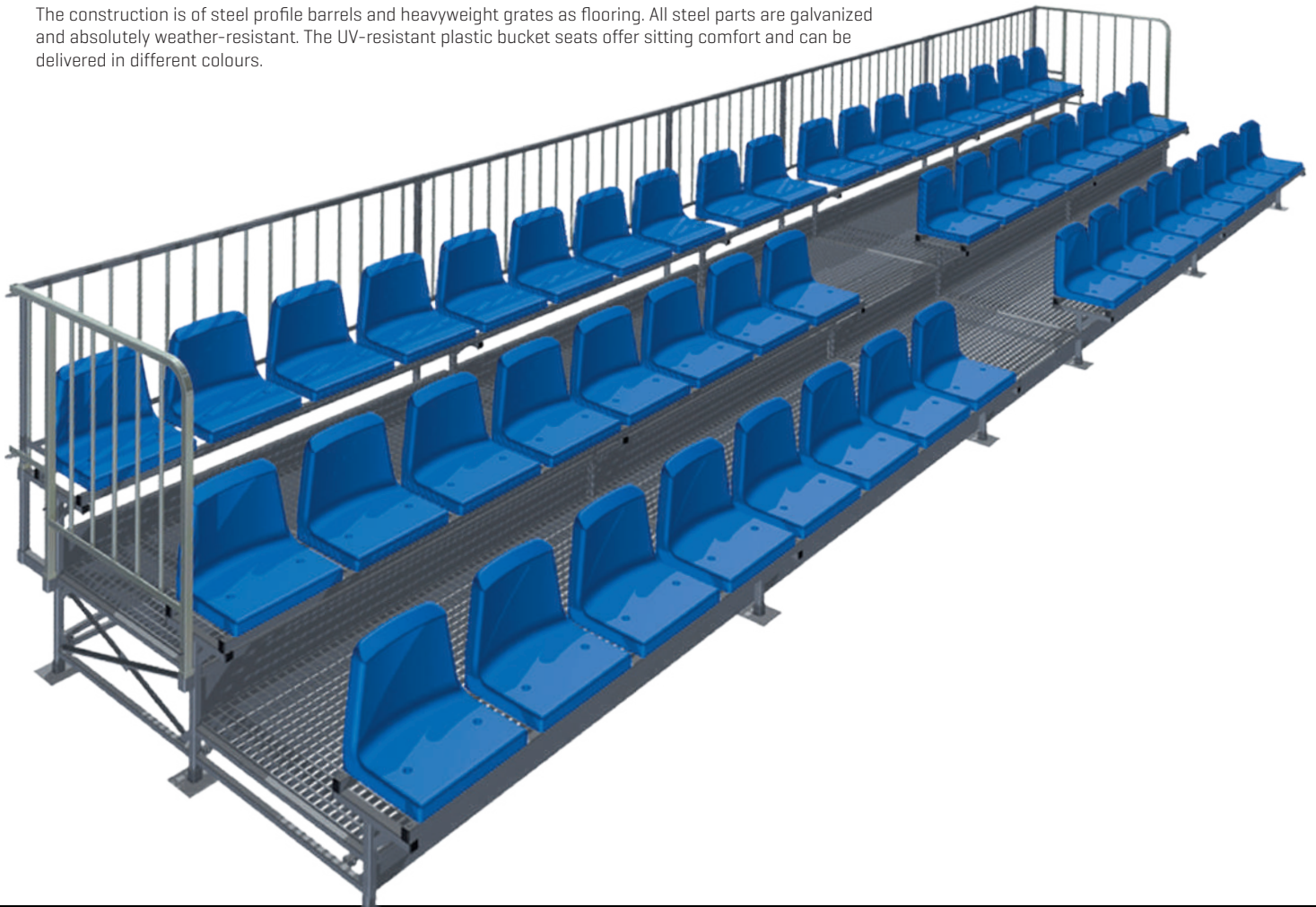

# Court Accessories



special manufacture

## Tribune Court Royal with 50 seats, three-rowed

### Technical data:

- Length: 9,19 m
- Depth: 2,13 m
- Height: 1,52 m
- Seat height: 0,84 m
- Capacity: 50 seats
- Material tribune: steel, galvanized
- Material seat: spray-applied propylene, impact-resistant, UV-resistant,

Available colours: see page 68 - 69  
No. 40985



## Universal Bank COURT ROYAL Fantastic

The brand-new aluminum bench from our own production. Put the bench together according to your desired colors. With only three screws, the seat shells can be attached to the aluminum frame. This modular system allows an enormous variety of colors. For example, you can take the colors of the home club. The frame is made of natural aluminum and is equipped with a sturdy cross brace.

Absolutely weatherproof seat shells and UV resistant. Due to the low weight the bench is easy to transport. Screws for fastening and cover caps are included. Height: 900 cm Width: 450 cm Length: 1960 cm No, 41221

## Ball Machines + Training Walls



### **Air-Tennis practice wall**

The recently developed Air-Tennis tennis practice wall is the ideal training partner for everyone, from beginners to experts. This product is a unique and absolutely unbeatable piece of training equipment for use in stationary or transportable mode. It comes in a bag and is easy to transport. To set it up, simply unfold it on the ground and roll it out. Use the bellows [supplied], then fill it with air - it just takes seconds. You can use the air pressure gage, also supplied, to check that the air pressure is at the right level, as this also affects the way the ball bounces back. There are also attachment straps on both sides for attaching the practice wall to our pairs of stands, fences, or sports hall walls. You can also empty it in seconds, simply by turning over the bellows. Players can play on both sides of the Air-Tennis practice wall. It has lines marked on it at the height of the net to guide the player. Tested by international trainers who rated it very highly.



# Ball Machines · Training Walls



## **Air-Tennis practice wall 3 m**

300 x 180 cm

No. 42020

## **Air-Tennis practice wall 4 m**

400 x 180 cm

No. 42021

## **Air-Tennis practice wall 5 m**

500 x 180 cm

No. 42022

## **Air Tennis practice wall set**

300 x 180 cm complete with stands.

No. 42025

## **Pair of stands**

No. 42024



# Ball Machines · Training Walls

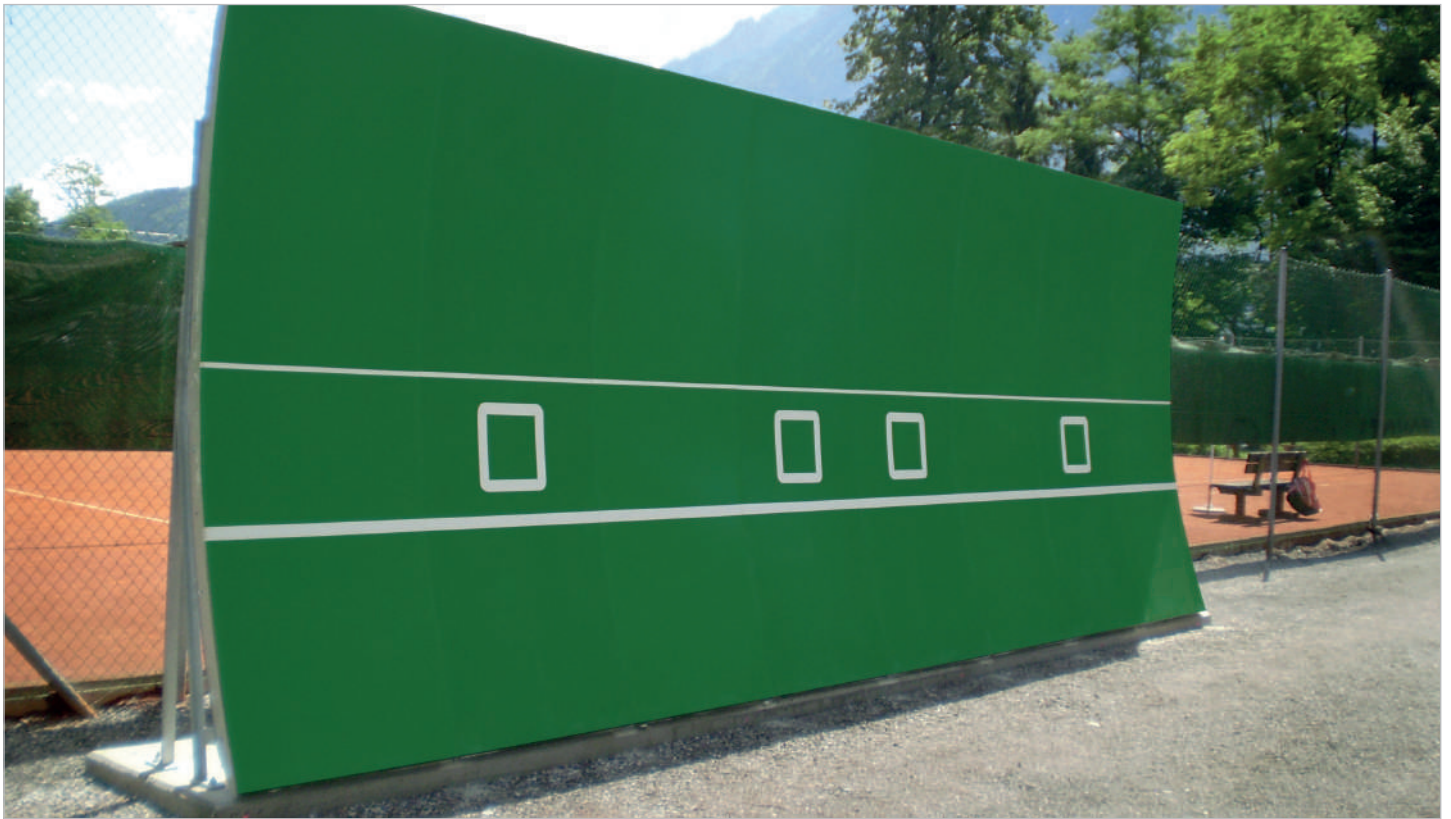

## Smash-Back Training Wall

Made of acrylic and frostproof concrete. Homogeneously sealed green coating offers additional protection. Parabolic playing surface guarantees a spot-on ball rebound. The white marking lines are indestructible. This training wall is simply mounted and bolted to a strip foundation with recessed anchor bolts. Can be supplied in two heights, 230 and 300 cm with a 100 cm protective screen. Width individually adjustable with elements. Integration of sound-proofing, recommended in residential areas.

### Typ II E

Playable on one side. Height 230 cm, element width 148 cm, without protective screen.

No. 42060

### Typ I E

Playable on one side. Height 300 cm, element width 100 cm, without protective screen.

No. 42062

### Protective screen Typ E

For single-sided playing walls. Hot galvanized, angled ball protective screen. 100 cm high.

No. 42064



### Noise Reduction Type I an II E

For single-sided playing walls, 2,30 and 3,00 m. Prefabricated acrylic concrete slabs with covering and insulating materials.

No. 42066

**Side panelling** for Smash-Back rebound wall

No. 42068



# Ball Machines · Training Walls



## Tennis Tutor ProLite

The wide speed range makes this machine a superb choice for all beginners. Due to the small size and light weight it can be stored easily and fits in almost all car trunks. A good choice for sports lessons in schools as well as for private use. The ball trajectory is manually adjustable from groundstroke to towering lob. The oscillator delivers shots randomly across the court.

### Technical details:

Ball capacity:	125 balls
Dimensions:	[HxWxD]: closed 31 x 50 x 46 cm
Weight:	13 kg
Power:	battery
Playing time:	2 - 3 hours
Recharging time:	12 hours
Feeding interval:	1.5-10 sec.
Top speed:	96 km/h
Ball flight:	stop to lob
Line-directions:	1 direction and random
Case:	plastic
Remote control:	no - on-off switch

No. 42013



## Tennis Twist

Especially designed for children and beginners. The Tennis Twist can be used in clubs and schools as well as in backyards, driveways and even basements. The machine is very easy to use - just turn it on and it shoots a ball every five seconds. The arc of the ball can be adjusted anywhere from approx. 3 - 6 meters.

### Technical details:

Ball capacity:	28 balls
Dimensions [HxWxD]:	50 x 20 x 20 cm
Weight:	5 kg
Power:	battery
Playing time:	5-6 hours
Feeding interval:	5 sec.
Top speed:	15 km/h
Ball flight:	straight
Lines-directions:	1 direction
Ball spin:	no
Case:	plastic
Remote control:	no on-off switch

No. 42016



## Tennis Tutor Plus

The ball machine Tennis Tutor PLUS is battery operated. It is portable and rollable like a suitcase when the handle is pulled out. The ball speed is adjustable from a light throwing ball for beginners to a high-speed ball for advanced players. The trajectory can be set between net roller and lob, regular ball sequence and arbitrary scattering angle.

### Technical details:

Ball capacity:	150 balls
Dimensions [HxWxD]:	51 x 50 x 50 cm
Weight:	21,6 kg
Power:	battery
Playing time:	4-6 hours
Recharging time:	12 hours
Feeding interval:	1,5-10 sec.
Top speed:	136 km/h
Ball flight:	short to long
Line-directions:	topspin, spin, flat, slice
Ball spin:	one direction and random
Housing:	plastic
Remote control:	yes on/off

No. 42012



## Ball machine Playmate VOLLEY DREAM

The ball machine Playmate Volley Dream is a high-quality portable ball throwing machine with aluminum housing and battery operation. It meets the highest safety requirements. There is a sensor installed, which immediately stops the ball ejection if a person stands in the immediate vicinity in the ejection direction. Furthermore, the new Volley Dream comes with a lockable lid, which must be locked for safety reasons in game mode. It can be set in seven directions. For example: right, middle, left, left right, right, middle. Likewise, it plays top spin and slice, as well as short-long. The ball sequence can be adjusted continuously to 6-60 pieces of balls per minute. An ideal device for individual or group training. Exact throwing accuracy and quiet running. With the newly integrated accessory „i-Playmate“ you can use an App to control the Playmate i-Shmash via the i-Phone or i-Pad, as well as record, document and compare your training achievements.

### Technical data:

- Capacity: about 180 balls with lid closed.
- Dimensions: (height x width x depth) 64 x 56 x 48 cm
- Weight: 31 kg
- Power connection: battery operation (charging current 230 V)
- Battery life: min 4 hours
- Charging time: 6 hours
- Top speed: 140 km / h
- Ball sequence: 1 - 10 sec.
- Trajectory: short-long, infinitely adjustable Ball Types Top Spin, Slice
- Ball Types: Top Spin and Slice
- Spread angle: 7 directions right-left-center
- Housing: aluminum with lockable lid
- Safety: Shut down sensors
- Remote control: wireless, on / off

No. 42005



## Remote Control Playmate

General remote control for all Playmate ball machines.

No. 420342



## Charger

For Playmate Transportable

No. 420033



## Power Pack

For Playmate Transportable

No. 420032

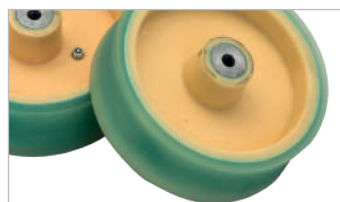

## Ejection Wheels

For Playmate Transportable

Diameter: 15,3 cm

No. 420031



## Ejection Wheels

For Playmate ACE and i-Smash

Diameter: 20 cm

No. 420341



## Covering Hood

For all Playmate Ball Machines

No. 42004 for Playmate Volley Dream

No. 42031 for Playmate-i-Smash Dream

## Ball machine Playmate i-Smash DREAM

The ball machine Playmate i-Smash is the highlight of the ball throwing machines. It meets the highest safety requirements. A sensor is installed, which stops the ball ejection immediately, if a person stands in direct proximity in ejecting direction. Furthermore, the new i-Smash will be delivered with a lockable lid, which must be made for safety reasons. It can be set in seven directions. For example: right, middle, left, left right, right, middle. Likewise, it plays top spin and slice, as well as short-long. The ball sequence can be adjusted continuously to 6-60 balls per minute. An ideal device for individual or group training. Exact throwing accuracy and quiet running. The housing is made of powder-coated aluminum. With the newly integrated accessory „i-Playmate“ you can use an App to control the Playmate i-Shmash via the iPhone or i-Pad, as well as record, document and compare your training achievements.

### Technical data:

- Capacity: about 240 balls with lid closed.
- Dimensions: [height x width x depth] 96 x 54 x 92 cm
- Weight: 35 kg
- Electricity: 230 V
- Top speed: 150 km / h
- Ball sequence: 1 - 10 sec.
- Trajectory: short-long, infinitely adjustable Ball Types Top Spin, Slice
- Ball Types: Top Spin and Slice
- Spread angle: 7 directions right-left-center
- Housing: aluminum with lockable lid
- Safety: Shut down sensors
- Remote control: wireless, on / off

No. 42008



## Playmate MOVER

This new ball collector collects all spread out balls in shortest time. Basket can be removed easily and emptied into the ball trolley or ball machine. The tentacles are retractable. High quality aluminum construction with big wheels. Basket can be hooked to the handle when balls are played.

No. 42076



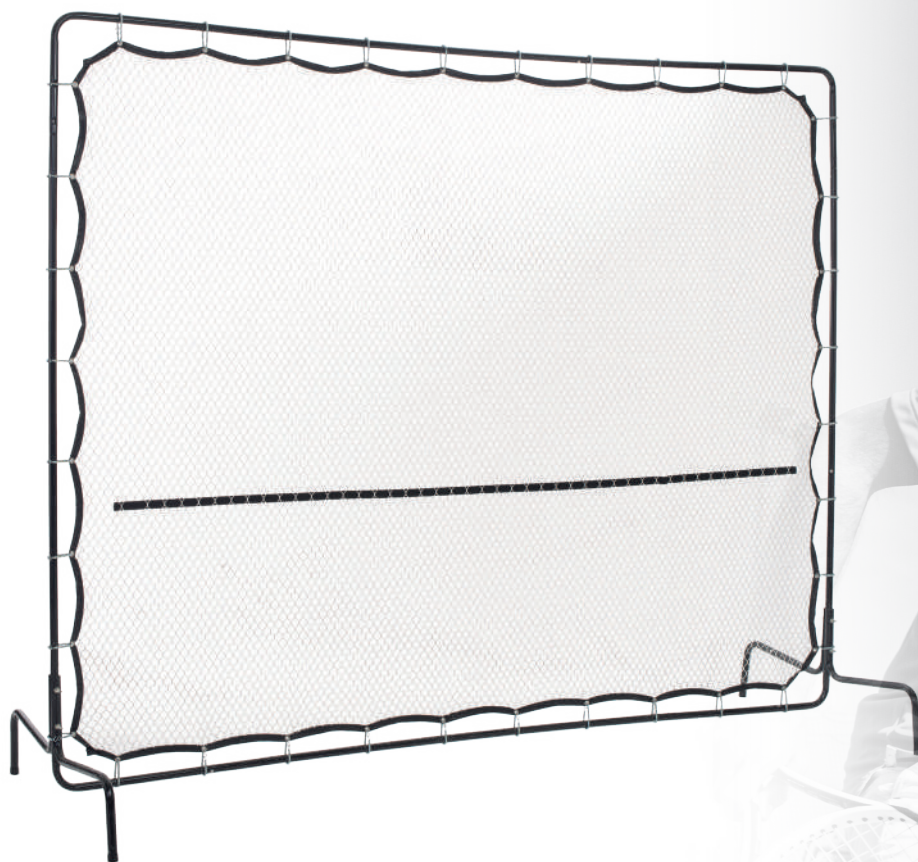

## **Tennis Net Training Wall**

Transportable net wall of enameled tubular steel.  
Infinitely adjustable, for different  
ball variations. Size: 2.80 x 2.20 m.  
No. 42040

## **Replacement Net** for Tennis Net

Training Wall 2.60 x 2.0 m.  
No. 42041

## **Replacement springs**

No. 42037





## Training Devices

# Training Devices



**Tripod for  
Multi Sports Radar  
No. 43002**

## Multi Sports Radar

This new speed control measuring instrument can be used for tennis, golf, football and many other ball games. The ball speed can be displayed within a few seconds.

Including mini tripod and bag.

Technical Data:

- Speed control from 5 to 199 km/h or 3 to 150 m/h
- Measuring distance from 1-12 m
- Three-figure LED-display with 55mm high digits
- Voice-announcement of the displayed digits is adjustable
- On the average batteries without voice are non-perishable ca. 50h, batteries with voice ca. 30h.
- Automatic switch-off- function for saving the batteries
- 5 AA batteries are needed (Not contained in consignment).
- Suitable for all tripods
- Dimensions: 18 cm x 15 cm x 12 cm

No. 43003



## Tennisball Collector K-MAX

The K-MAX is the fastest ball collector. Simply roll up the balls and empty them with the opening mechanism into the ball basket. This makes fun and you only lose little time. The K-MAX only weighs 3kg including an aluminum handle with suspension and it has a capacity of 60 balls.

No. 42125



# Training Devices



## CLAX® Ball Trolley

This newly developed trolley is essential for all tennis trainers. Due to the use of aluminum and a high-grade plastic, a high durability is guaranteed. The easily smooth-running wheels are bearing mounted and are equipped with lever brakes. Foldable within seconds. Storable in almost all trunks. A 46 l folding box is included but any other 32 or 46 l boxes can also be used. The boxes can be transported on the upper as well as on the lower platform. Load capacity of upper level 20 kg and the lower platform 40 kg.

Dimensions:

Completely opened: [L x W x H] 55 x 103 x 89 cm, folded together: [L x W x H] 55 x 71 x 18 cm

Cage Height: 85 cm, Cage size: [L x W x H] 60 x 34 x 26 cm

Capacity: 120 balls, Weight: 10 kg

No. 26000

## Replacement box for CLAX trolley

No. 26001

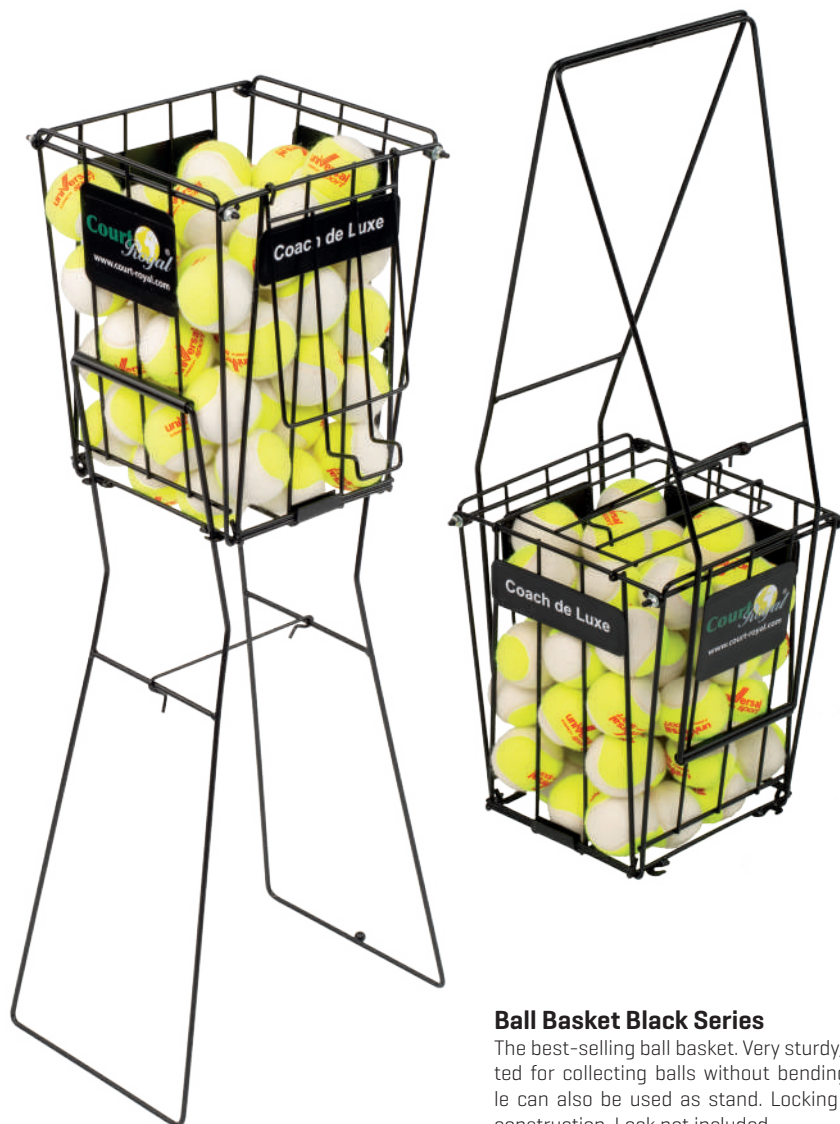

## Ball Basket Black Series

The best-selling ball basket. Very sturdy, chrome-plated for collecting balls without bending over. Handle can also be used as stand. Locking cover, sturdy construction. Lock not included.

Capacity: 70 balls.

No. 42080



## Ball Pickup Tube Court Royal

Saves time and efforts picking up balls. Simply press this practical tube down onto the balls on the floor and it picks them up. Holds 17 balls. To empty the tube, just open the cover at the opposite end.

Length 120 cm, Weight: 0.8 kg

No. 42053

# Training Devices



## Ball Basket Court Royal Easy Pack Black Series

The new ball basket leaves nothing to be desired. The ball basket Easy Pack with detachable bag for 120 balls can be easily folded and stored in a small space. The mobile rack is made of aluminum.

No. 42054



## Ball Trolley Court Royal Black Series

Very stable trolley, easily moveable thanks to large pulleys. Big ball basket and extra storage tray. The poles, baskets and the lockable lid, without lock, are black powder-coated.

Capacity: 330 balls, Size: [L x W x H] 60 x 49 x 92 cm, Cage Size: [L x W x H] 60 x 49 x 36 cm, Weight: 10 kg.

No. 43021



## Separating Grid For Ball Trolley Court Royal

With the separating grid you can separate two different ball types.

No. 430215

## JOWO Tennis Caddy Black Series

The ideal partner for professional tennis trainers. Three height adjustment settings, simple and fast handling in transport. Can be folded for storage in a small space. Lockable cover. Sturdy, weatherproof structure. Capacity: 220 balls.

No. 42087

# Training Devices



## Tennisball Balls Unlimited Code black

A combination of natural rubber and woven English Playnes felt. In our range of products this excellent tournament ball guarantees maximum performance and stability. Clearly less expensive than comparable brands. ITF approved tournament quality.

No. 46014 pack of 4



## Tennisball Balls Unlimited Code Red

A combination of natural rubber and woven TTI-felt. This tournament ball guarantees maximum performance and stability. A superb playing behavior and an excellent price/quality-ratio. ITF approved tournament quality.

No. 42093 pack of 4



## Tennisball Court Royal Coach

High-quality woven needle felt, perfect price/quality ratio, popular with trainers, excellent stability. Suited for ball machines.

No. 42091 yellow

pack of 60



## Sport Coach

High-quality woven English TTI-felt. Pressureless tennisball in tournament quality. The long-lasting elasticity of the pressureless core guarantees extremely long stability. Especially suited for ball machines.

No. 42094 yellow/white

pack of 60



## Sport Coach

High-quality woven English TTI-felt. Pressureless tennisball in tournament quality. The long-lasting elasticity of the pressureless core guarantees extremely long stability. Especially suited for ball machines.

No. 42090 yellow

pack of 60

# Training Devices



## Marking Markers

Ideal for marking in training. Soft hemisphere with 20 cm Ø in 4 different colors, height 9 cm, 40 pieces stacked on a carrier pole.  
No. 20351



## Hurdles Set

6 hurdles, adjustable in height to 20 cm and 33 cm. Width 44 cm, complete with bag.  
No. 21560

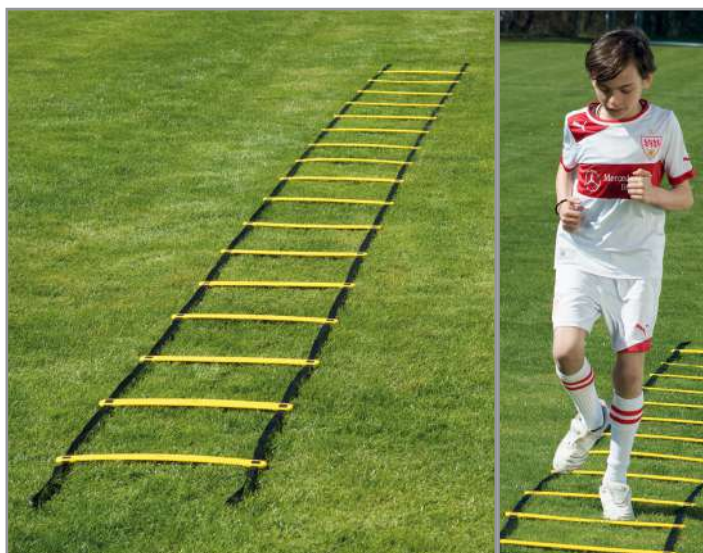

## Coordination Ladder

Very good coordination and fitness training, due to flat strips fixed to a fabric band making injury almost impossible, suitable for many surfaces, robust quality. Dimensions: 800 cm long, 50 cm wide, 45 cm distance between strips, complete with bag.  
No. 42045

# Training Devices



## Marking Plates

Made of soft PVC, diameter 19 cm, height, 50 plates in 5 different colors, per color 10 pieces  
**No. 20454** Packaging unit 50 plates



## 1) Marking Cone 40

Plastic, 40 cm high, for multiple use.  
**No. 20392** red, **No. 20393** yellow, **No. 20395** green, **No. 20396** blue

## 2) Marking Cone 28

Plastic, 28 cm high  
**No. 20373** red, **No. 20374** yellow, **No. 20375** green, **No. 20376** blue

## 3) Marking Cone 24

Red plastic, 24 cm high.  
**No. 20377**

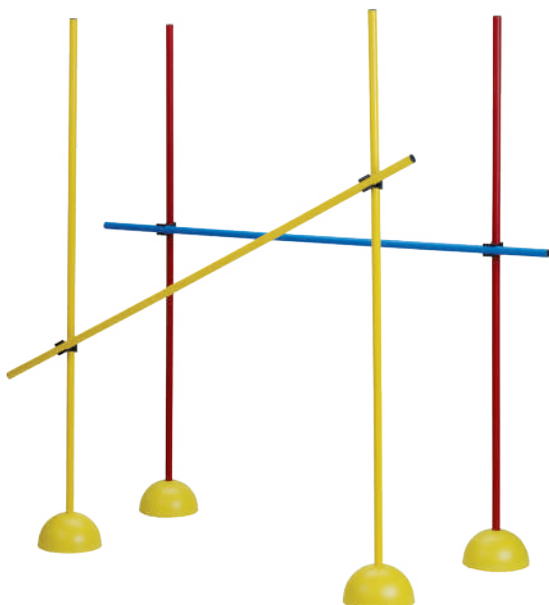

## Training Aid

The exercise/training aid for all types of sports is a complete training system with countless potential applications; from tennis, football, track and field, handball, basketball right through to motor sports. There are no limits to the imagination of trainers and athletes. The exercise aid can be used for school sports, basic training, right through to professional sports. Base can be filled with sand or other dry materials. Poles are made of high-grade elastic plastic. They can be inserted into the base or used as crossbars. The newly developed plastic clip can be set to any position. The poles can be positioned loosely or clipped onto other poles.

Complete set consists of:

2 bases, 3 poles 160 cm long, 2 solid plastic clips

**No. 20315** 1 set

**No. 20316** 5 sets

## Foot Plastic half bowls

**No. 20317**

## Plastic Pole 160 cm long

**No. 20318**

# Training Devices



## Medicine Balls

Made of rubber with non-slip surface and needle valve.

No. 22023	1000 g
No. 22025	2000 g
No. 22026	3000 g
No. 22027	4000 g
No. 22028	5000 g



## Jump Rope

Colored plastic rope with sturdy handle.

No. 565	red	230 cm
No. 567	yellow	240 cm
No. 568	green	250 cm
No. 569	blue	260 cm



## Fun Bal

The fun ball bounces in all directions. Ideal for reaction-training.

No. 420951	7 cm
------------	------



## Fitness dumbbell 2 kg

Hexagonal fist dumbbell covered with colored vinyl. Comfortable in the hand and gentle on the ground. Easy to clean.

No. 702301
------------



Kid's Tennis

# Kid's Tennis



**Tennisball**  
**Balls Unlimited Stage 1**  
 High-quality woven flex felt. 25% slower and 10% lighter than normal tennisballs. ITF approved.  
 No. 45080 pack of 12



**Tennisball**  
**Balls Unlimited Stage 2**  
 High-quality woven flex felt. 40% slower and 20% lighter than normal tennisballs. ITF approved.  
 No. 45081 pack of 12



**Tennisball**  
**BIMBI Easy Stage 2**  
 High-quality woven flex felt. 40% slower and 20% lighter than normal tennisballs. Applied over years in smallfield-tennis-championships, ITF approved. Weight: approx. 43g. An absolute premium product.  
 No. 460020 pack of 12



**Tennisball**  
**Balls Unlimited Stage 3**  
 High-quality woven flex felt. 6% larger and 20% lighter than normal tennisballs. ITF approved.  
 No. 45082 pack of 12



**Foam Ball Stage 3**  
 Soft foam ball especially developed for starting off on the small field and midcourt. Distinctly larger than Stage 1 + 2 balls, slower bounce and flight behavior.  
 No. 42096 pack of 12



**Stage 1 Children's Racket**  
 The perfect racket for children aged between 8 and 12 years! For full court, length: 64 cm, weight: 220 g.  
 No. 45075



**Stage 2 Children's Racket**  
 The perfect racket for children aged between 7 and 11 years! For mid court, length: 60 cm, weight: 200 g.  
 No. 45073



**Stage 3 Children's Racket**  
 The perfect racket for children aged between 5 and 8 years. For mini court, length: 54 cm, weight: 180 g.  
 No. 45072



**Stage 4 Children's Racket**  
 The perfect racket for children aged between 3 and 5 years. For mini court, length: 48 cm, weight: 170 g.  
 No. 45071



**Stage 5 Children's Racket**  
 The perfect racket for children aged under 3. For mini court, length: 43 cm, weight: 150 g.  
 No. 45074



# Kid's Tennis

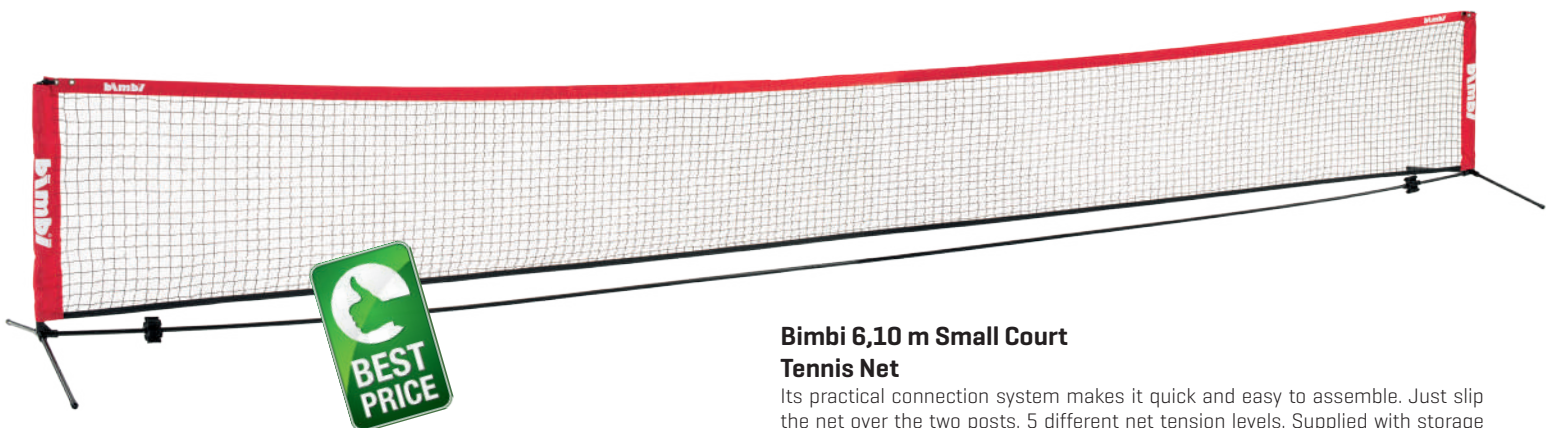

## **Bimbi 6,10 m Small Court Tennis Net**

Its practical connection system makes it quick and easy to assemble. Just slip the net over the two posts. 5 different net tension levels. Supplied with storage bag. Size: 6.10 x 0.85 m  
No. 40506

## **Bimbi Replacement Net 6,10 m**

No. 40509



## **Bimbi 3 m Small Court Tennis Net**

Its practical connection system makes it quick and easy to assemble. Just slip the net over the two posts. 5 different net tension levels. Supplied with storage bag. Size: 3 x 0.85 m  
No. 40500

## **Bimbi Replacement Net 3 m**

No. 40501



## **Bimbi Small Court Tennis Net, 3 m Street Set**

Just like the Bimbi 3m Small Court Tennis Net, but with 2 Topspin 60 cm tennis rackets and 6 Bimbi Easy balls.  
No. 40512



## **Bimbi Small Court Tennis Net, 6.10 m School Set**

Just like the Bimbi Small Court Tennis Net 6.10 m but with 4 Topspin 60 cm tennis rackets and 12 Bimbi Easy balls.  
No. 40510

# Kid's Tennis

## Bimbi Small Court Tennis System

This practical system was used in the small court tennis project run by the German Tennis Association and has proved its value. Fast and simple to assemble. Stable when assembled because of its wide stands. Ideal net tension with self-tensioning system.

Can be stored in a small space in a practical bag.

Official German Tennis Association size: 6.10 x 0.85 m. Weight approx. 6.5 kg.

No. 40488

## Replacement net 610

No. 40489

## Bag

No. 40503

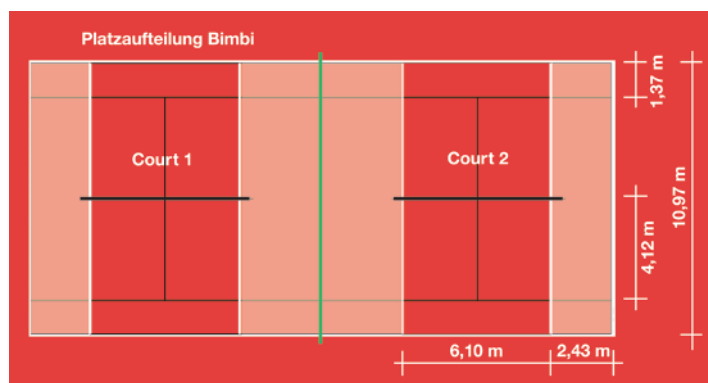

## Marking trolley for Tennis

New product developed for children's tennis, spreading width approx. 50 mm.

No. 45005

## Chalk for Tennis Courts

5 kg. in pail  
No. 45009

# Kid's Tennis

## Bimbi Club Package II

Consists of: 1 Bimbi small court tennis system, 4 Bimbi children's rackets and 1 Bimbi Easy-Set.  
No. 46033



## Bimbi School Tennis Package II

Consists of: 2 Bimbi small court tennis systems, 16 Bimbi children's rackets and 2 Bimbi Easy-Sets.  
No. 46031



### Circle Marking Tape

Made of high quality PVC, can be used on all surfaces. Set of 4, green.  
No. 43018

### Line Marking Tape

Made of high quality PVC, can be used on all surfaces. Set of 10, green.  
No. 46041

### Corner Marking Tape

Made of high quality PVC, can be used on all surfaces. Set of 4, green.  
No. 43016



# Kid's Tennis

## Children's Net System

Sturdy aluminum system, 40 x 40 mm tubes. Easy to dismantle and to transport. Consists of 2 aluminum bases including posts, each 3.05 m long, 2 net holding rods and a nylon net. Dimensions 6.10 m x 0.85 m. No. 40491

## Children's Net System mobile

Like article No. 40491 but with 6 rollers. No. 40493

## Children's Net Nylon

6.10 x 0.85 m  
No. 40564



## Marking Lines for Kid's Tennis

Marking lines for small court tennis. Made of heavy-duty, non-slip and indestructible PVC. The weight of the line keeps it flat on the ground and it needs no additional fixation. Marking set of 2 rolls, 11 m long, 8 cm width. No. 45000 white

## Youth Stage 2

Rubber lines for the original Stage 2 court. 2 side lines: 3 cm, 2 base lines 4 cm wide. Color white. Excellent UV resistance. Supplied with fixing nails and assembly instructions. Original length: 17.83 x 6.17 [single] or 8.23 m [double]. No. 45001

## Youth Stage 3

Rubber lines for at least 2 original Stage 3 courts. 4 lines, 6.60 m each (can be extended to 11 m) color white. Excellent UV resistance. Supplied with fixing nails and assembly instructions. Includes tennis court lines. No. 45002



Ball Sports + Equipment



## Volleyball Post Heavy Duty

Absolutely weatherproof, very sturdy, vandalism-proof, competition-approved volleyball post made of 90 x 90 x 4 mm hot-dip galvanized steel profile. Height adjusted with a very easy-to-handle mechanism. Net tensioned with a turnbuckle. Complete with ground sleeves 35 cm. Post length 300 cm.  
No. 30510

## Volleyball Post Universal 80 Aluminum

Reliable, solid volleyball post 80 x 80 mm aluminum, compliant with DIN 7896. Easy-running net attachment and tensioning devices (galvanized, trapezoid thread mechanism) continuously adjustable. Surface of the posts and impulse profiles are matt-silver anodized. Complete with ground sleeves and covers.  
No. 30500

## Volleyball Post Universal 83 Aluminum

Reliable, solid volleyball post 83 mm made of aluminum special profile, compliant with DIN 78966. Easy-running net attachment and tensioning devices continuously adjustable. All steel parts are galvanized. Post surface is matt-silver anodized. Complete with ground sleeves and covers.  
No. 30501

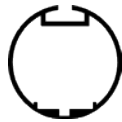
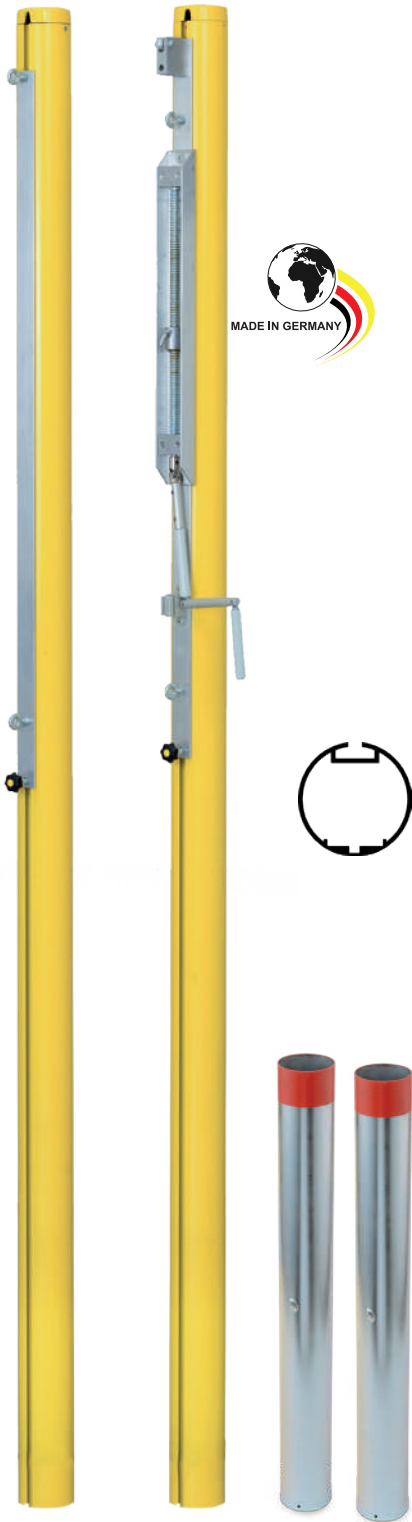

## Beach Volleyball Post Court Royal 83

83 mm Ø aluminum (DIN 7896). Easy running net attachment and tensioning devices (galvanized, trapezoid thread mechanism) steplessly adjustable. Surface is yellow powder-coated.

**Delivery without ground sleeves**  
No. 30693

## Ground sleeves

Made of hot-dip galvanized steel for installation in sand fields, length 70 cm  
No. 30694



## Volleyball Referee Tower

Umpire chair made of aluminum special profile Ø 35 mm, height-adjustable, 3 adjustment options, complete with 4 rubber pads, 2 lashing straps and writing board.  
No. 30600



## Volleyball Referee Tower Professional

Solid steel construction, painted black, height-adjustable, wooden platform. Ladder entry from the back. Two transport wheels for the easy transport of the umpire chair. Used at numerous volleyball tournaments.  
No. 30603



## Beach Volleyball Marking Lines

9 x 18 m, made of polyester tape 50 mm, with loops at each corner and middle marking. Complies with the GVF [German Volleyball Federation] requirements. Wounded onto a plastic roll. Complete with 4 ground anchors.  
No. 30688

## Beach Volleyball Marking Lines Turnier

9 x 18 m (or 8 x 16 m) with adjustable plastic corner elements, 50 mm wide PES-webbing and middle marking. Complete with 4 plastic ground anchors, 23 cm long and bungee tensioning ropes. color: dark blue.  
No. 30686





### Badminton Umpire Chair

Elegant aluminum badminton umpire chair with European Seal of Approval DIN EN 131. Very robust because of the stable ladder and the projecting supports with four base plates. The seat mount has an extra crossbar behind the UV-resistant body-contoured seat. Including writing-board.  
No. 30888



### Badminton Post Court Royal

protecting rubber buffers on the support part. Game columns made of 80 x 80 mm special aluminum profile. Including tension belt and slidable eyebolt slide for unclamping the net. Steel parts painted blue, aluminum parts silver anodised. Weight 80 kg, width ca. 86 cm, projection 70 cm.  
No. 30828



### Badminton Post I

For competitions and school sports. Post made of 50 x 50 mm aluminum profiles. Complete with hooks, tensioning belt and ground sleeves.  
No. 30802

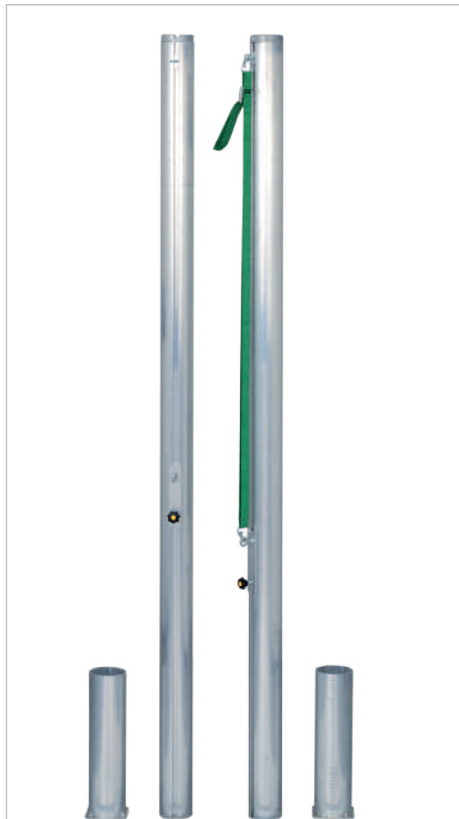

### Badminton Post II

For competitions and school sports. Posts made of ø 83 mm aluminum special profile. Complete with hooks, tensioning belt and ground sleeves.  
No. 300802



### Badminton Post Hobby

Movable free-standing system with rubber wheels on the weighted base. Posts made of 40 x 40 mm steel pipe. Complete with hooks and tensioning belt, painted blue. Weight per post approx. 25 kg, radius 60 cm  
No. 30803



# Ball Sports + Equipment



## Universal Posts Cort Royal freestanding

Can be used outdoors as well as in the hall. The multi-game system is suitable for all net and line games. Due to the easy-to-read scale with game markers, a height adjustment is easily possible, even if the net is stretched. The system consists of two base frames weighing 118 kg each. Ball-bearing solid rubber-wheels allow easy transport with set weights. The system is equipped with bottom-protecting rubber points on the underside. The 80 x 80 mm steel columns are infinitely adjustable from 1,00 - 2,45 m and equipped with a safety lock. An all-purpose net [length 6,10 m] is included. The following types of game are possible: tennis - children's tennis - fistball - volleyball - beachvolleyball - football tennis - bouncing ball - Indiacca - ring tennis - badminton.

No. 32001



## Additional Weight for tournament use

Steel weight with handle, blue painted. Including bolts for attaching to universal posts Cort Royal.

Weight 38 kg

No. 30848

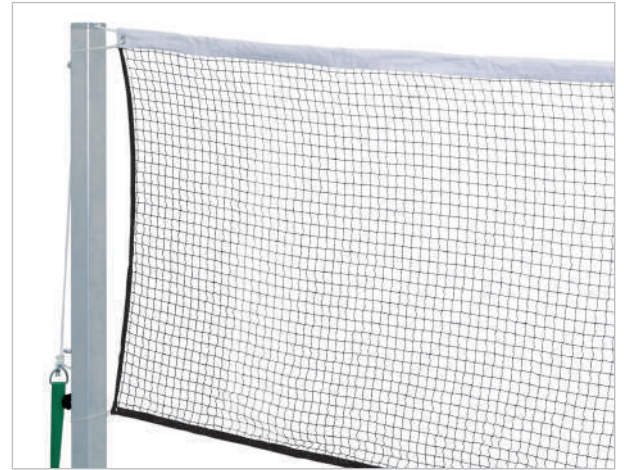

## Badminton Net Training

Made of 1 mm nylon cord, with tensioning cord. Size 6.10 m wide, 76 cm high. Mesh size 18 mm, edged all round.

No. 30840

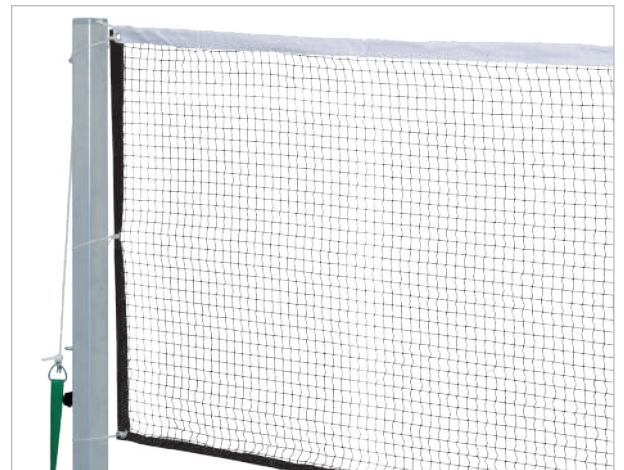

## Badminton Net Olympia

Made of 1.2 mm nylon line with tensioning steel wire, 6.60 m long. Size 6.02 m wide, 76 cm high, mesh size 18 mm, edged all round.

No. 30860

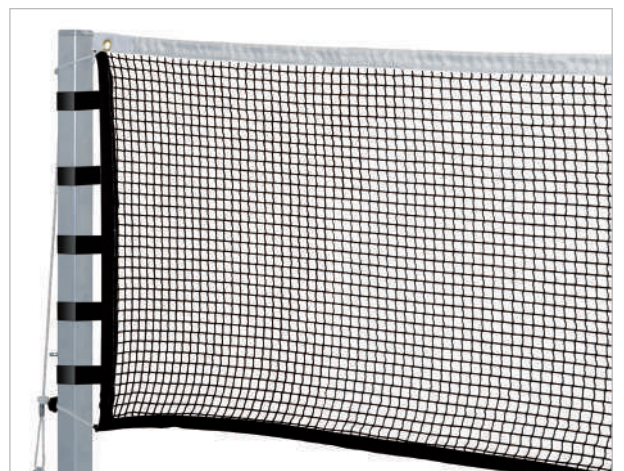

## Badminton Net Court Royal Super Cup

Made of 1.2 mm black nylon cord. Size 6.02 m wide, 76 cm high, mesh size 20 mm. White PES framing on top, 75 mm, with twisted PE rope 8,0 m. Both sides and bottom bordered with 30 mm black PES lateral framing. On both sides there are 5 velcro fasteners to attach the net to the posts.

No. 30850

# Ball Sports + Equipment

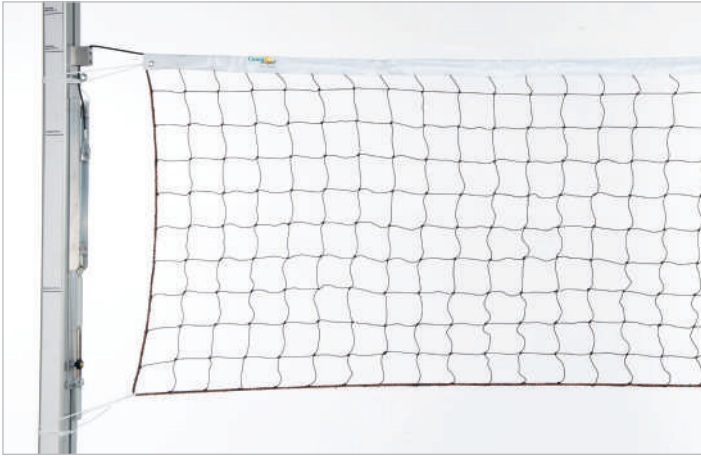

## Volleyball Net Court Royal Training 2 mm

Black polyethylene net 2 mm, with 100 mm wide edging on top in white, and 5 mm coated steel cable 11, 7 m. Mesh size 100 mm. Dimensions: 9,5 m x 1 m  
No. 30620



## Volleyball Net Court Royal Competition 3 mm

Black polyethylene net 3 mm, with 100 mm wide edging on top in white, and 5 mm coated steel cable 11, 7 m. Mesh size 100 mm. Dimensions: 9,5 m x 1 m  
No. 30660



## Beach Volleyball Net Court Royal 2 mm

Black polyethylene net 2 mm, 9,5 m long, 1 m high, with 50 mm wide coated edging in green. Mesh size 100 mm. Dimensions: 8,5 m x 1 m  
No. 30684

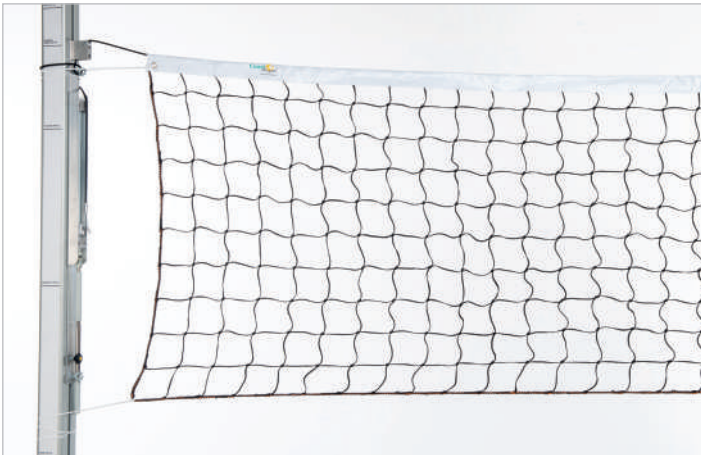

## Beach Volleyball Net Competition Net

Top 3 mm, low-stretch polyester tensioning rope, bottom 4 mm tensioning rope. With 4 tensioning cords as well as 75 mm wide coated edging in neon yellow. Mesh size 100 mm. Dimensions: 9,5 m x 1 m  
No. 30681



## Volleyball Antenna one piece

With GVF certification mark, length 180 cm, complete with bag and marking tape.  
No. 30675

# Ball Sports + Equipment



## **Soccer Tennis Unit Bimbi 3 m**

Its practical connection system makes it quick and easy to assemble. Just slip the net over the two posts. 5 different net tension levels. Supplied with storage bag.  
Size: 3 x 0.85 m  
No. 40500

## **Bimbi Replacement Net 3 m**

No. 40501

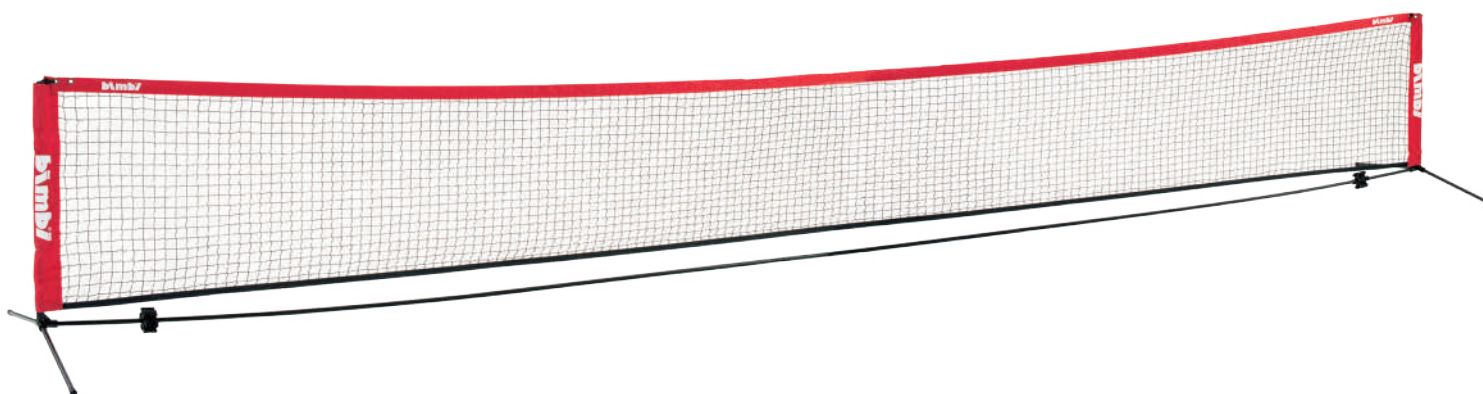

## **Soccer Tennis Unit Bimbi 6,10 m**

Its practical connection system makes it quick and easy to assemble. Just slip the net over the two posts. 5 different net tension levels. Supplied with storage bag. Size: 6.10 x 0.85 m  
No. 405060

## **Bimbi Replacement Net 6,10 m**

No. 40509



## Youth Soccer Goal Court Royal 3 x 2 m, completely welded, in 4 parts

The newly developed Youth Soccer Goals Court Royal are delivered in four parts. Their stability comply with the fully-welded aluminum-goals. The fully-welded side frames are joined by 102 mm long round profile bars which are fitted with very sturdy interior profiles to join the parts together. Goalposts and bars are made of aluminum. The warp-resistant profile is fitted with a particularly deep groove, in which the plastic net-holders are inserted. According to regulations a tilt-resistant ground anchoring for grassy fields is included. Alternatively anti-tilt weights for synthetic fields are available. The goal meets the FIFA and DFB standards and is produced according to DIN EN 748.

Dimensions: 3 x 2 m, Depth at base: 1,25 m

No. 202022



## Youth Soccer Goal Court Royal, fully welded, in four parts

The newly developed free-standing Youth Soccer Goals Court Royal are made of plain aluminum and are delivered in four parts and comply with its stability with the fully-welded aluminum goals. The goal frames and base frames are of 120 x 100 mm oval profiles. The two side elements are fully-welded and are connected with the cross bar by super stable interior profiles.

The torsion-free special profile is fitted with a groove in which the provided plastic net holders can be inserted. For additional charge of 7 % the goals can be delivered with an integrated net holder. According to regulations an ant-tilt-resistant ground anchoring for grassy fields is included.

Alternatively an anti-tilt-resistant ground anchoring for hard courts is available as well. The goals comply with the FIFA and DFB standards, are produced according to DIN EN 748 and are safety tested [ GS-tested ]. Dimensions: 5 x 2 m

No. 202021 1,5 m width

## Youth Soccer Goal Net Borussia

Very sturdy net made of high-strength 4 mm polypropylene.

No. 20240 green

No. 20241 white



## Handball Goal Court Royal

According to safety standard DIN-EN 749, goal frame 3 x 2 m welded, standard goal depth 1.25 m [optional 1.45 m]. Made of especially thick-walled 80 x 80 mm aluminum profile with rounded edges, base pipe for screwing in, very sturdy rear construction, base frame made of 75 x 50 mm square aluminum profile with guide groove, net hoop made of 50 x 3 mm round pipe for free net suspension [the net is not pulled over the hoops].

No. 20520

## Small Field and Handball Goal Net

High-strength 4 mm polypropylene

No. 20610 white

No. 20611 green

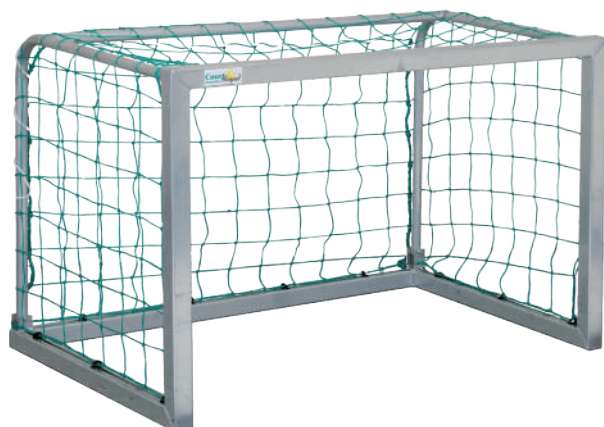

## MINI Aluminum Training Goal

120 x 80 cm, 80 cm deep. Hinged net brackets, with floor tube. Complete with net made from high-strength 3 mm polypropylene. 10 cm mesh width.

No. 202081 adjustable

No. 2020811 fully-welded

## Replacement Goal Net

No. 202082 mesh width 10 cm

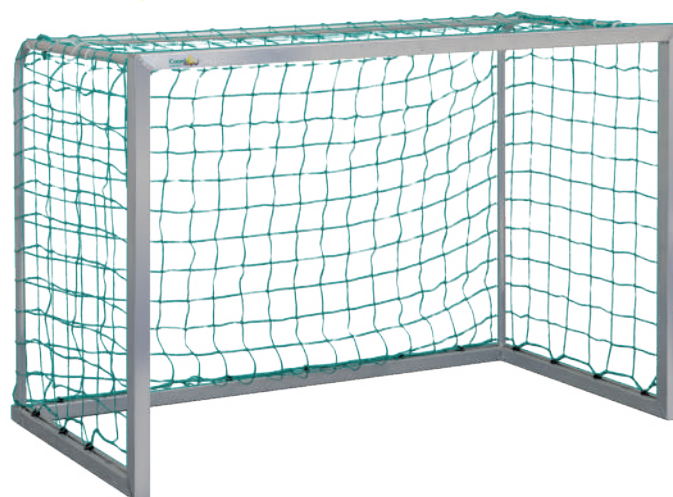

## MAXI Aluminum Training Goal

180 x 120 cm, 80 cm deep. Hinged net brackets, with floor tube. Complete with net made from high-strength 3 mm polypropylene. 10 cm mesh width.

No. 202091 adjustable

No. 2020911 fully-welded

## Replacement Goal Net

No. 202092 mesh width 10 cm



### Streetball Unit Court Royal with Grid Backboard

Stable single-post structure made from 90 x 90 mm steel tube, hot-dip galvanized with screw-on plate for basket. Grid backboard 120 x 90 cm, including super-stable basket ring with chain net, galvanized, including ground sleeve.

No. 300262 extension 120 cm  
No. 300222 extension 165 cm



### Streetball Unit Court Royal Heavy Duty with Aluminum Backboard

Stable single-post structure made from 90 x 90 mm steel tube, hot-dip galvanized with screw-on plate for basket. Including target backboard made from 8 mm solid aluminum 120 x 90 cm, painted white. Including super-stable basket ring with chain net, galvanized, including ground sleeve.

No. 300232 extension 120 cm



### Streetball Unit Court Royal Heavy Duty with Grid Backboard

All-metal competition streetball system made of galvanized steel pipe 114 x 4.5 mm. Steel grid board, extra low-noise, hot-dip galvanized, 120 x 90 cm. Powder-coated with flat iron enhancement for fixing. DIN drill-holes, with chain net.

No. 300230 extension 120 cm



### Basketball System Court Royal with GFK Backboard round

Stable single-post structure made from 90 x 90 x 4 mm steel tube, hot-galvanized, fully welded with screw-on plate for basket. Ground sleeves are hot-galvanized with anti-lift device. GS approved, produced according to DIN EN 1270. Made in Germany. GFK board in rounded shape 120 x 90 cm with an orange-coloured DIN-basket and a 6 mm nylon net, including ground sleeves.

No. 30026 extension 120 cm  
No. 300220 extension 165 cm



### Basketball System Court Royal with Aluminum Board 120 x 90 cm

Stable single-post structure made from 90 x 90 x 4 mm steel tube, hot-galvanized, fully welded with screw-on plate for basket. Ground sleeves are hot-galvanized with anti-lift device. GS approved, produced according to DIN EN 1270. Made in Germany. A massive 8 mm strong aluminum board, angular form 120 x 90 cm with Big Duty basket and a chain net which is attached at 12 points, including ground sleeves.

No. 30022 extension 120 cm  
No. 300264 extension 165 cm



### Stabilizing bracket for basketball board

Additionally for all basketball boards. Provides an even better stabilization of the board and reduces oscillations and vibrations.

No. 300269



## Big Duty Basketball System

Steel tube single-pole frame made from square profile 15 x 15 cm, hot-dip galvanized, projection 165 cm, fully-welded. Including target backboard made from 8 mm solid aluminum 120 x 90 cm, painted white. Including super-stable basket ring with chain net, galvanized. Basket is screwed directly to frame and therefore prevents target backboard from being damaged if subjected to extreme stress. The system is extremely stable, weather-resistant, maintenance-free and vandalism-proof, therefore ideal for use on public playgrounds and sports facilities, galvanized. Basket is screwed directly to frame and therefore prevents target backboard from being damaged if subjected to extreme stress.

No. 30027 with Alu backboard 120 x 90 cm square

No. 30038 with Alu backboard round 120 x 90 cm



## Basketball Basket DIN red

According to international standard. Red powder-coated, complete with back plate with DIN drill holes 11 x 9 cm. Without net.

No. 300229

## Basketball Net Ultra

Nylon cord 6 mm.

No. 30230 white



## Basketball Basket Ultra Flex 70

Match basket according to international regulations. (DIN 1270) Double spring folding mechanism in closed safety housing. Inclination of the basket from 70 kg ring load. Red, powder coated with DIN drilling 11 x 9 cm. Without net.

No. 30227

## Basketball Basket Ultra Flex 30

Match basket according to international regulations. (DIN 1270) Double spring folding mechanism in closed safety housing. Inclination of the basket from 30 kg ring load. Red, powder coated with DIN drilling 11 x 9 cm. Without net.

No. 31040 [without illustration]



## Basketball Basket Big Duty

Indestructible basketball basket made of hot-dip galvanized steel. With DIN drill holes 11 x 9 cm. Without net.

No. 300219

## Chain Net

Galvanized steel.

No. 30233

# Ball Sports + Equipment



### Streetball Backboard Fiberglass

Weather resistant, anti-vibration Fiberglass Board. With black print on the side. Incl. DIN holes. Dimensions: 120 x 90 cm.  
No. 30212

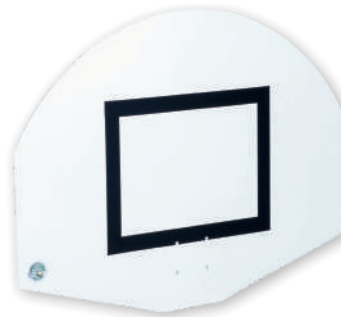

### Streetball Backboard Alu

Made of 8 mm solid, fully welded aluminum. White powder coated. Incl. DIN holes. Dimensions: 120 x 90 cm.  
No. 30214

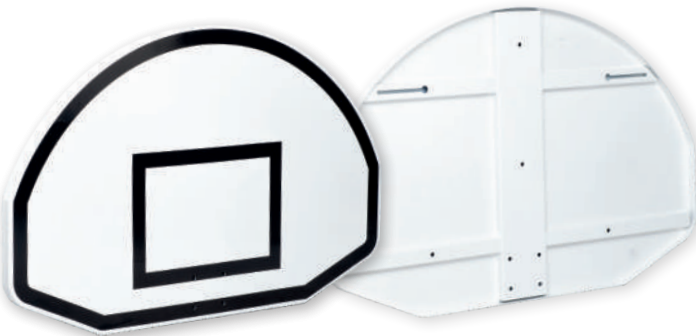

### Basketball Backboard Heavy Duty steel

White powder coated 4 mm thick steel board in Fan design. Absolutely weatherproof. Including DIN holes. Dimensions: 135 x 90 cm  
No. 300121

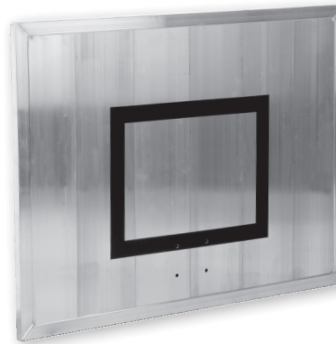

### Basketball Backboard Alu

Very stable anodized aluminum with reinforcement of the edges. Long-lasting and weather resistant. Perfect outdoor use. For highest demand. Vandalism-proof. Incl. DIN holes. Dimensions: 120 x 90 cm.  
No. 30216

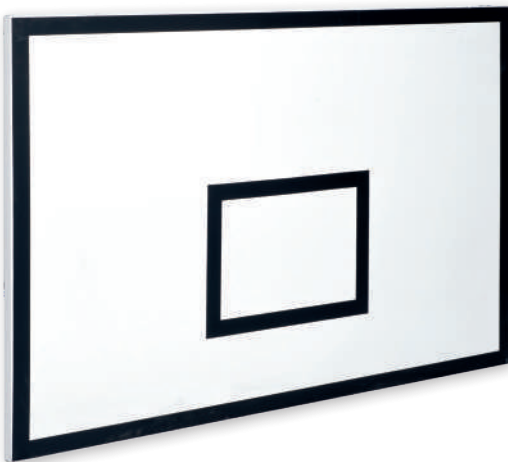

### Basketball Backboard Fiberglass

Absolutely weather resistant, anti-vibration Fiberglass Board without holes. Wooden core for individual attachment. Dimensions: 180 x 120 cm.  
No. 30200

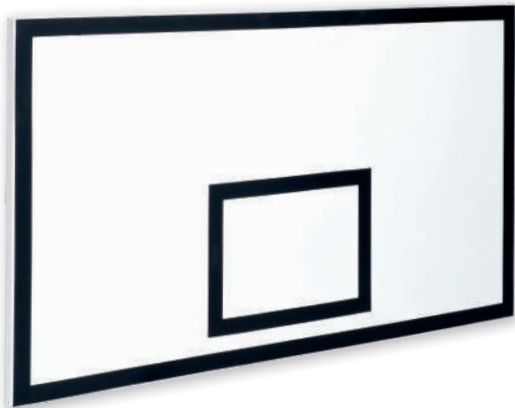

### Basketball Backboard Fiberglass

Absolutely weather resistant, anti-vibration Fiberglass Board without holes. Wooden core for individual attachment. Dimensions: 180 x 105 cm.  
No. 30201

### Streetball Grid Backboard

Made of fully welded grid. Low noise and wind permeable. Suitable for residential areas. Vandalism protected. Incl. DIN holes.

No. 300112 120 x 90 cm

No. 300115 180 x 105 mm

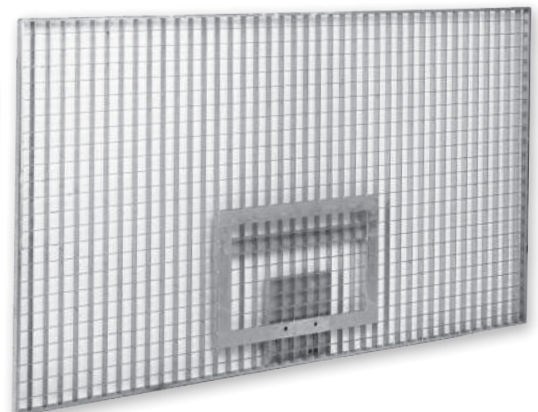
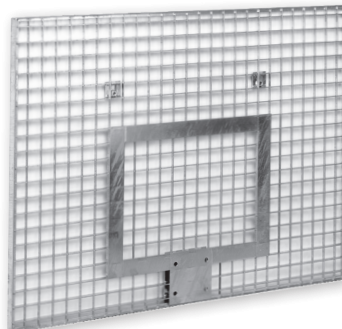





### Streetball Set Street

Weather-resistant plastic backboard 112 x 73 cm.  
Complete with basket and net.  
No. 310208



### Wall Mount

Wall fastening with approx. 30 cm extension.  
DIN drill holes 7.5 x 6.5 mm  
No. 300682

DIN drill holes 11 x 9 mm  
No. 300683



### Streetball Unit New York

Powder-coated steel post Ø approx. 95 mm to be set into concrete. Board 112 x 73 cm, basket Ø 45 cm and net. Height adjustable from 2.00 to 3.05 m. Extension 60 cm  
No. 31020

### Streetball Unit Atlanta

Free-standing, robust mobile system made from powder-coated steel tubing approx. 95 mm Ø. The base can be filled with sand [approx. 190 kg]. Weather-resistant, recyclable plastic backboard 112 x 73 cm complete with solid steel basket 45 cm Ø and nylon net. Basket height 3.05 m.  
No. 310201

### Streetball Unit Los Angeles

Free-standing, robust mobile system made from powder-coated steel tubing. The base can be filled with sand [approx. 190 kg]. The height of the basket can be automatically adjusted using a lever from 3.05 m [competition] to 2.10 m [kids]. Weather-resistant, recyclable plastic backboard 112 x 73 cm, complete with solid steel basket 45 cm Ø, nylon net and arm.  
No. 310203

# Ball Sports + Equipment



**LED-Scoreboard TENNIS**



## Carrying Case

For storing and transporting the display device. With shoulder strap and two carrying handles made of durable material.

No. 40895

## LED-Scoreboard P5 for 9 Disciplines

Tennis Table Tennis Squash Badminton Padel Volleyball Beach Volleyball

Dedicated application allows using tablet/smartphone to transmit score to scoreboard display in real time (Android + IOS)

Game analysis

Displaying marketing content

Tournament automatic management (soon)



## Scoreboard P5 for many ball sports

Electronic score display for indoor and outdoor use in real time. Scores and results are transferred directly from the tablet or smartphone via Bluetooth, (Android + IOS).

The electronic scoreboard's own operating system with software and app allows interference-free data transmission with a range of up to 80 meters. Advertising and information can also be displayed on a smartphone, tablet or laptop via a Wi-Fi PC interface with an optional Wi-Fi card and pre-installed app.

## Specifications

Screen Resolution:	128 x 96 pixels
Screen dimensions:	640 mm x 480 mm
Weight:	13 kg
Wi-Fi card:	(optional) TF-E6UW+hub75E005
Display function:	Text and graphic
Clear view:	Daylight 70-80 meter
Bluetooth:	Bluetooth 4.0 up to 70 m range
Tripod:	included
<b>No. 40896</b>	

## Wi-Fi PC Card

The wi-fi PC card is inserted into Scoreboard and together with a dedicated application it allows the user to send advertising and marketing material from laptops/smartphones/tablets (android + IOS).

## Wi-Fi Card for advertising

(Optional) TF-QB1+HUB75Q010 WI-FI  
No. 40897

# Ball Sports + Equipment

## Scorli LED-Scoreboard P10 for 9 Disciplines

The big electronic score display for indoor and outdoor use in real time. Scores and results are transferred directly from the tablet or smartphone via Bluetooth, (Android + IOS).

The electronic scoreboard's own operating system with SCORLI software and app allows interference-free data transmission with a range of up to 100 meters.

Advertising and information can also be displayed on a smartphone, tablet or laptop via a Wi-Fi PC interface with an optional Wi-Fi card and pre-installed app.

No. 40898



### Specifications

Screen Resolution:	128 x 96 pixels
Screen dimensions:	1280 mm x 960 mm
Weight:	45 kg
Wi-Fi card:	[optional] TF-E6UW+hub75E005
Display function:	Text, graphics, video
Clear view:	Daylight 100 meter
Bluetooth:	Bluetooth 4.0 up to 70 m range
Power supply:	110 -240 V
Tripod:	not included

No. 40896



# Court Dimensions

## Badminton Court Dimensions

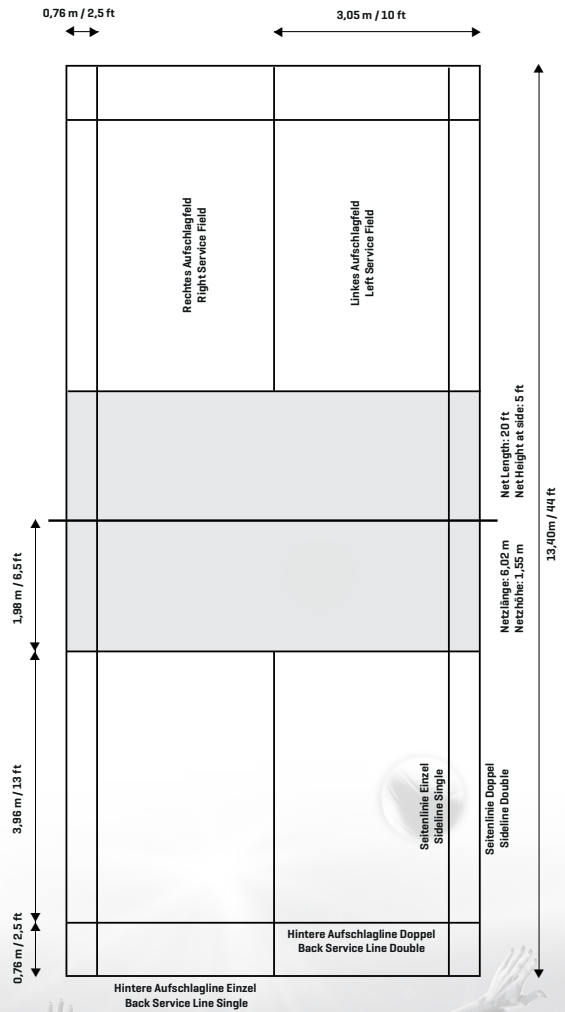

## Volleyball Court Dimensions

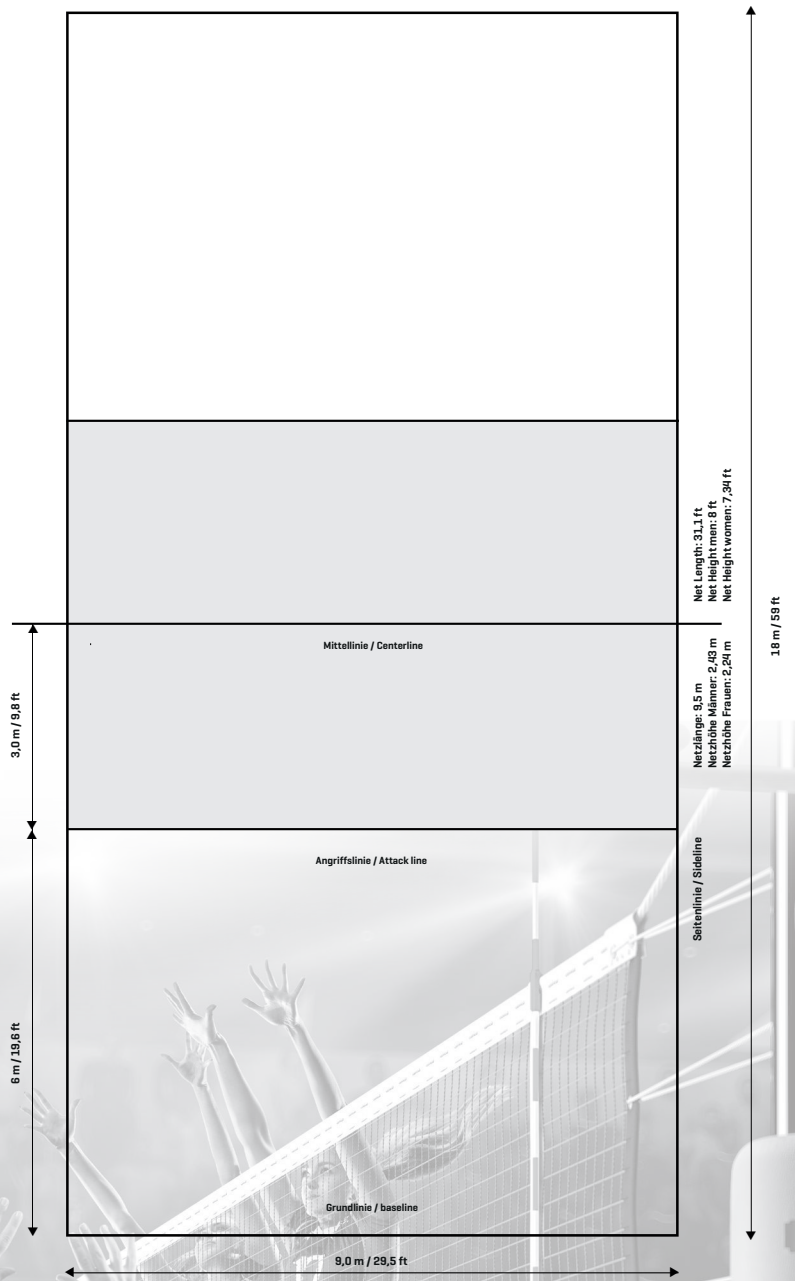

Court Width: 20 ft  
Court Breite: 6,10 m



# Tennis Net Altimeter

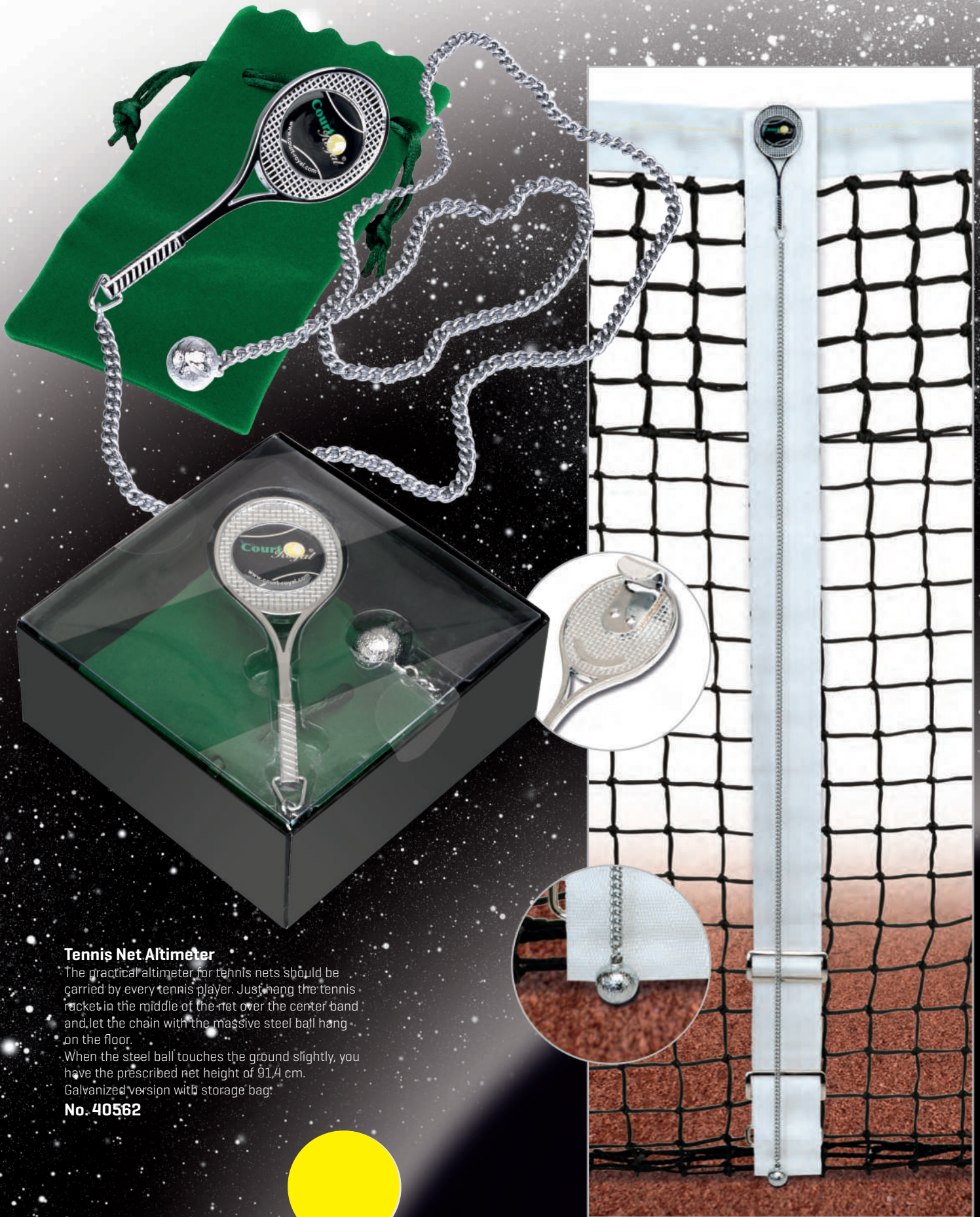

## Tennis Net Altimeter

The practical altimeter for tennis nets should be carried by every tennis player. Just hang the tennis racket in the middle of the net over the center band and let the chain with the massive steel ball hang on the floor.

When the steel ball touches the ground slightly, you have the prescribed net height of 91,4 cm.

Galvanized version with storage bag.

No. 40562



# Black Series

## Tennis Net Post Court Royal TP 880 // 83

Round post, Ø 83 mm. Special reinforced aluminum profile with groove for fastening the net holding rod. Internal trapeze tensioning mechanism with an aluminium key for easy net tensioning. Clip-on cap made of cast aluminum including safety chain. Overall length of posts: 142 cm. Weight: 10.5 kg. Aluminum ground sleeves, depth of insertion 35 cm, complete with cast aluminium cover. Meets the European DIN EN 1510 safety standard.

**Delivery without ground sleeves**

TP 80 No. 404461

TP 83 No. 404471



## Universal Bank COURT ROYAL Fantastic

The brand-new aluminum bench from our own production. Put the bench together according to your desired colors. With only three screws, the seat shells can be attached to the aluminum frame. This modular system allows an enormous variety of colors. For example, you can take the colors of the home club. The frame is made of natural aluminum and is equipped with a sturdy cross brace.

Absolutely weatherproof seat shells and UV resistant. Due to the low weight the bench is easy to transport. Screws for fastening and cover caps are included. Height: 900 cm Width: 450 cm Length: 1960 cm No, 41221

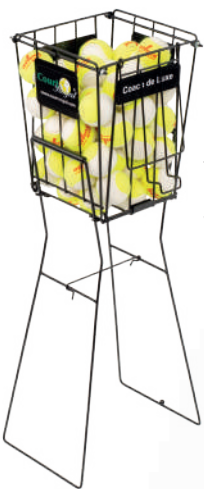

## Ball Basket Black Series

The best-selling ball basket. Very sturdy, chrome-plated for collecting balls without bending over. Handle can also be used as stand. Locking cover, sturdy construction. Lock not included.

Capacity: 70 balls.

No. 42080



## Ball Basket Court Royal Easy Pack Black Series

The new ball basket leaves nothing to be desired. The ball basket Easy Pack with detachable bag for 120 balls can be easily folded and stored in a small space. The mobile rack is made of aluminum.

No. 42054



## Advertising Umpire Chair Court Royal Deluxe Grand Slam

This heavy duty chair is ideal for advertising with 2 side panels of 10 mm PVC and 3 mm panels between steps. Plastic-coated aluminum base with UV-resistant seat and PVC table. Supplied without advertising. Supplied in standard color white, also available in green or other RAL colors on request.

No. 408101 white

## 4-color digital printing

Please provide file for printing.

No. 407934

**DOMOTRADE SIA**  
TEL. +371 29228597  
DOMOTRAD@GMAIL.COM  
WWW.DOMOTRAD.LV

**FACEBOOK/INSTAGRAM:**

"DOMOTRAD TENNIS"

## Ball Trolley Court Royal Black Series

Very stable trolley, easily moveable thanks to large pulleys. Big ball basket and extra storage tray. The poles, baskets and the lockable lid, without lock, are black powder-coated.

Capacity: 380 balls. Size: [L x W x H] 60 x 49 x 92 cm.

Cage Size: [L x W x H] 60 x 49 x 36 cm.

Weight: 10 kg.

No. 43021

www.domotrad.lv

domotrad@gmail.com